



Grid-connected PV Inverter

SUN-25K-G02-LV

SUN-30K-G02-LV

User Manual



Contents

| | |
|--|--------|
| 1. Introduction | - 1 - |
| 1.1 Appearance introduction | - 1 - |
| 1.2 Parts list | - 2 - |
| 2. Safety warnings and instructions | - 3 - |
| 2.1 Safety signs | - 3 - |
| 2.2 Safety instructions | - 3 - |
| 2.3 Notes for using | - 4 - |
| 3. Operation interface | - 5 - |
| 3.1 Interface view | - 5 - |
| 3.2 Status indicator | - 5 - |
| 3.3 Buttons | - 6 - |
| 3.4 LCD display | - 6 - |
| 4. Product Installation | - 7 - |
| 4.1 Select installation location | - 7 - |
| 4.2 Inverter of inverter | - 9 - |
| 4.3 Inverter Installation | - 10 - |
| 5. Electrical connection | - 11 - |
| 5.1 DC input connection | - 11 - |
| 5.2 AC terminal connection | - 13 - |
| 5.3 Connection of the ground line | - 16 - |
| 5.4 Inverter monitoring connection | - 16 - |
| 6. Start up and shut off | - 18 - |
| 6.1 Start up the inverter | - 18 - |
| 6.2 Shut off the inverter | - 18 - |
| 7. Zero export function via SUN limiter | - 19 - |
| 7.1 Sun Limiter function wiring diagram | - 19 - |
| 7.2 Connect the SUN limiter to inverter | - 20 - |
| 7.3 Debugging Limiter | - 23 - |
| 7.4 Zero-export function (Option) | - 24 - |
| 7.5 Notes while using zero export function | - 30 - |
| 7.6 How to browse the load power of your PV grid-tie plant on monitoring platform? | - 30 - |
| 8. General Operation | - 32 - |
| 8.1 The initial interface | - 33 - |
| 8.2 Statistics information | - 35 - |
| 8.3 Fault Record | - 37 - |
| 8.4 ON/OFF setting | - 38 - |
| 8.5 Parameter setting | - 39 - |
| 9. Repair and Maintenance | - 55 - |
| 10. Error information and processing | - 55 - |
| 10.1 Error code | - 55 - |
| 11. Specifications | - 60 - |

About This Manual

The manual mainly describes the product information, guidelines for installation, operation and maintenance. The manual cannot include complete information about the photovoltaic (PV) system.

How to Use This Manual

Read the manual and other related documents before performing any operation on the inverter. Documents must be stored carefully and be available at all times. **Contents may be periodically updated or revised due to product development. The information in this manual is subject to change without notice.** The latest manual can be acquired via service@deye.com.cn

1. Introduction

1.1 Appearance Introduction

On-grid inverter can convert solar panel DC power into AC power which can directly input to the grid. Its appearance is shown below. These models contain SUN-20K-G02-LV, SUN-25K-G02-LV, SUN-30K-G02-LV, SUN-35K-G02-LV. The following is collectively referred to as “inverter”.

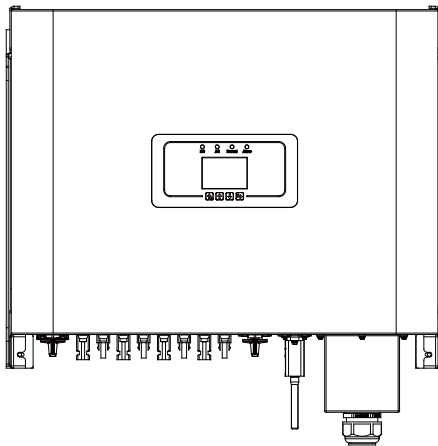

Pic 1.1 Front view

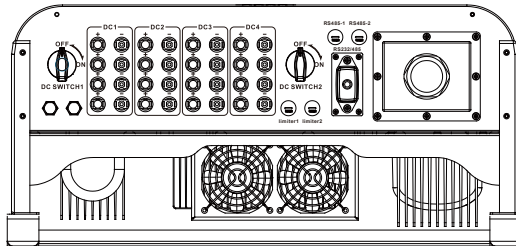

Pic 1.2 Bottom view

1.2 Parts list

Please check the following table, to see whether all the parts are included in the package :

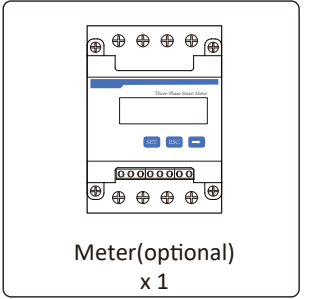
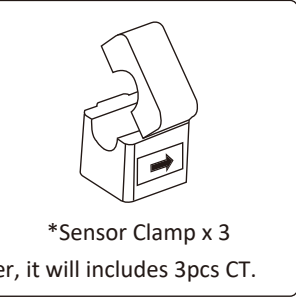
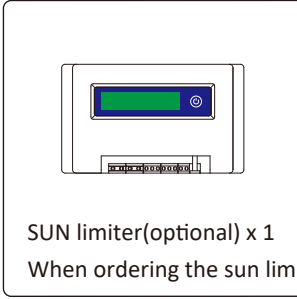
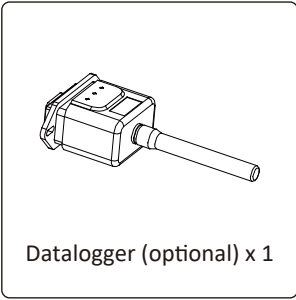
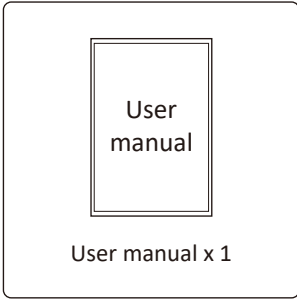
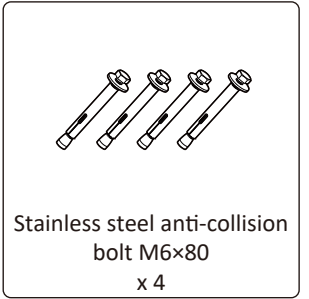
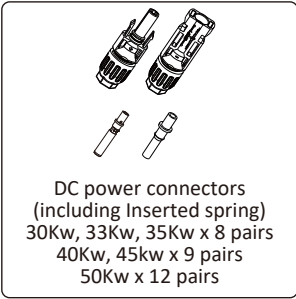
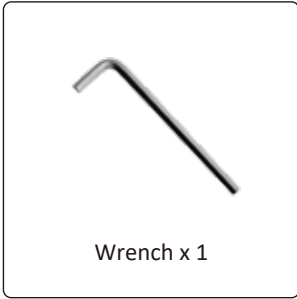
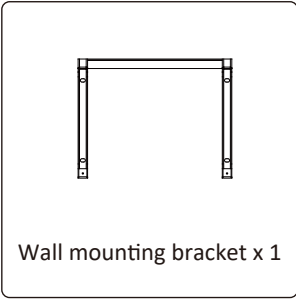
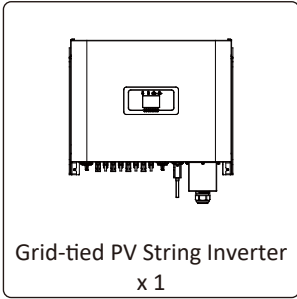

2. Safety warnings and instructions

Improper use may result in potential electric shock hazards or burns. This manual contains important instructions that should be followed during installation and maintenance. Please read these instructions carefully before use and keep them for future reference.

2.1 Safety signs

Safety symbols used in this manual, which highlight potential safety risks and important safety information, are listed as follows:



Warning:

Warning symbol indicates important safety instructions, which if not correctly followed, could result in serious injury or death.



Shock Hazard:

Caution, risk of electric shock symbol indicates important safety instructions, which if not correctly followed, could result in electric shock.



Safety Hint:

Note symbol indicates important safety instructions, which if not correctly followed, could result in some damage or the destruction of the inverter.



High Temperature Hazard:

Caution, hot surface symbol indicates safety instructions, which if not correctly followed, could result in burns.

2.2 Safety instructions



Warning:

Electrical installation of the inverter must conform to the safety operation rules of the country or local area.



Warning:

Inverter adopts non-isolated topology structure, hence must insure DC input and AC output are electrical isolated before operating the inverter. Strictly prohibit grounding the positive and negative poles of the PV string. Otherwise it will damage the inverter.



Shock Hazard:

Prohibit disassembling inverter case, there existing shock hazard, which may cause serious injury or death, please ask qualified person to repair.



Shock Hazard:

When PV module is exposed to sunlight, the output will generate DC voltage. Prohibit touching to avoid shock hazard.



Shock Hazard:

While disconnect the input and output of the inverter for maintenance, please waits for at least 5 mins until the inverter discharge the remnant electricity.



High Temperature Hazard:

Local temperature of inverter may exceed 80 °C while under operating. Please do not touch the inverter case.

2.3 Notes for using

The three phase string power inverter is designed and tested under related safety regulations. It can ensure the personal safety of the user. But as a electric device, it may cause shock or injury by incorrect operation. Please operate the unit under below requirements:

1. Inverter should be installed and maintained by qualified person under local standard regulations.
2. Must disconnect the AC side first, then disconnect DC side while doing installation and maintenance, after that, please wait at least 5 mins to avoid getting shocked.
3. Local temperature of the inverter may exceed 80 °C while under operating. Do not touch to avoid getting injured.
4. All electrical installation must be in accordance with local electrical standards, and achieved permission of local power company.
5. Please take appropriate anti-static measure.
6. Please install where children can not touch.

3. Operation Interface

3.1 Interface View

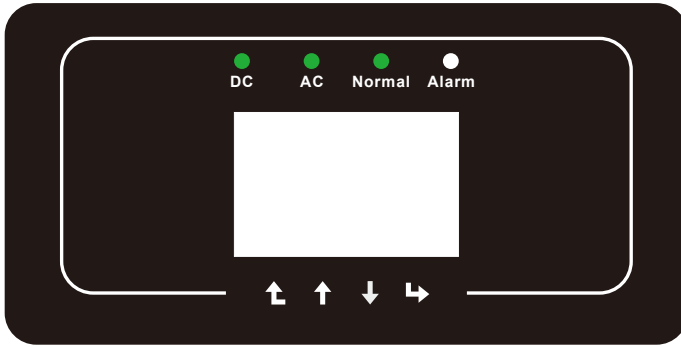

Pic 3.1 Front panel display

3.2 Status Indicator

The inverter panel has 4 indicators, the left one is dc output indicators, green indicates normal DC input. Beside is the AC indicator, green indicating normal ac connection. Beside the AC indicator is the operating indicator, green indicating normal output. The right indicator is alarm. red indicates alarming.

| Indicator | status | Explanation |
|------------------|---------------|----------------------------------|
| ● DC | on | Inverter detects DC input |
| | off | Low DC input voltage |
| ● AC | on | Grid Connected |
| | off | Grid Unavailable |
| ● NORMAL | on | Under normal operating |
| | off | Stop operating |
| ● ALARM | on | Detected faults or report faults |
| | off | Under normal operating |

Table 3.1 Status indicator lights

3.3 Buttons

There are four buttons on the inverter panel : Above is Up and increase button(UP), Below is down and decrease button(DOWN), Left is ESC button(ESC), Right is Enter button(ENTER). Achieving below functions by the four buttons :

- Page turning (use UP and DOWN button);
- Modify adjustable parameters (use ESC and ENTER button).



3.4 LCD Display

Three phase string inverter use 256*128 dot formation display, Display below content :

- Inverter operation status and information;
- Operating information
- Warning message and malfunction display.

4. Product installation

4.1 Select installation location

To select a location for the inverter, the following criteria should be considered:

WARNING: Risk of fire

- Do not install the inverter in areas containing highly flammable materials or gases.
- Do not install the inverter in potentially explosive atmospheres.
- Do not install in small closed spaces where air can not circulate freely. To avoid overheating, always make sure the flow of air around the inverter is not blocked.
- Exposure to direct sunlight will increase the operational temperature of the inverter and may cause output power limiting. It is recommended that inverter installed to avoid direct sunlight or raining.
- To avoid overheating ambient air temperature must be considered when choosing the inverter installation location. It is recommended that using a sun shade minimizing direct sunlight when the ambient air temperature around the unit exceeds 100°F/40 C .



Pic 4.1 Recommended installation place

- Install on a wall or strong structure capable of bearing the weight.
- Install vertically with a maximum incline of $\pm 15^\circ$. If the mounted inverter is tilted to an angle greater than the maximum noted, heat dissipation can be inhibited, and may result in less than expected output power.
- If install more than one inverter, must leave at least 500mm gap between each inverter. And each inverter must be at least 500mm above and below. And must install the inverter at the place where children cannot touch. Please see picture 4.3.
- Consider whether the installation environment is helpful to see the inverter LCD display and indicator status clearly.
- Must offer a ventilate environment if inverter installed in the airtight house.



Safety Hint:

Do not place or store any items next to the inverter.

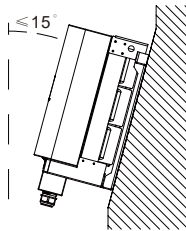
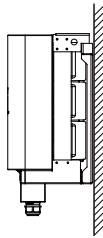
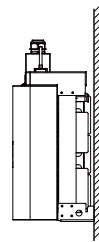
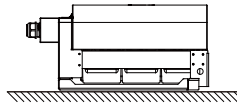
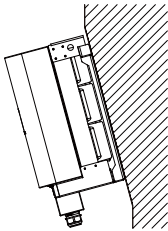

Pic 4.2 Installation Angle

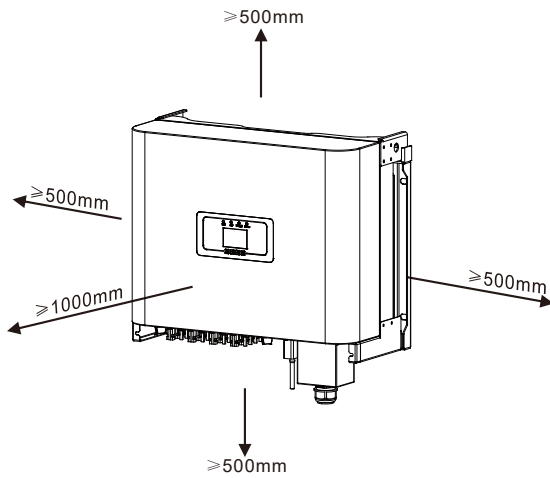

Pic 4.3 Installation Gap

4.2 Inverter of inverter

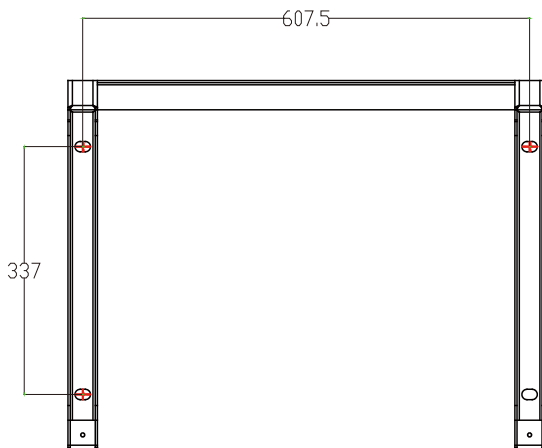

Pic 4.4 Mounting bracket dimensions

4.3 Inverter Installation

The inverter should be mounted in a vertical position. The steps of mounting are as follows

1. For brick walls, the position of the holes should be suitable for the expansion bolts.
2. Make sure the bracket is horizontal and the mounting holes are in the correct points. Drilling the holes on the wall according the marks.
3. Using the expansion bolts to fix the bracket to the wall.

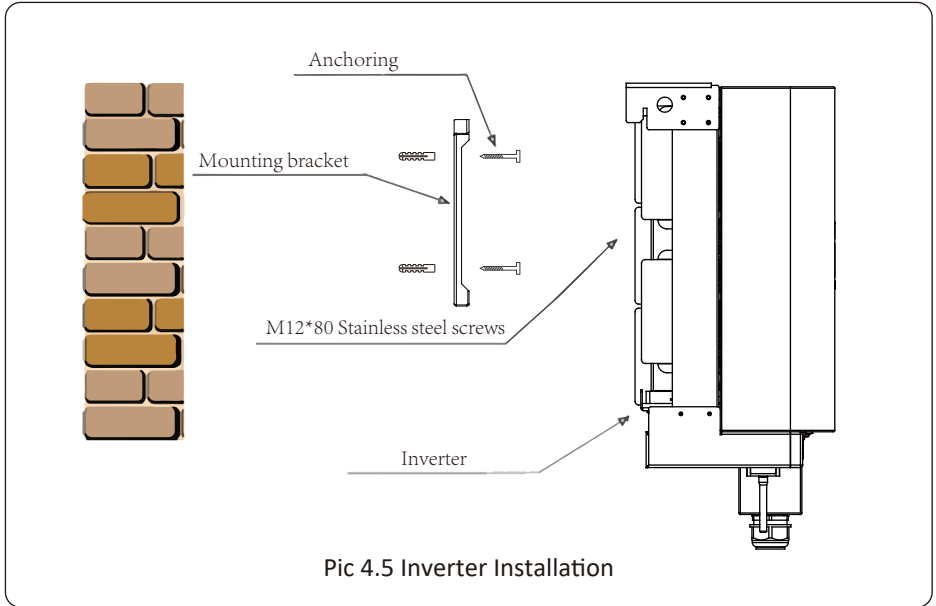

5 Electrical Connection

5.1 DC input terminal connection

1. Switch the Grid Supply Main Switch(AC)OFF.
2. Switch the DC Isolator OFF.
3. Assemble PV input connector to the inverter.



Safety Hint:

Please don't connect PV array positive or negative pole to the ground, it could cause serious damages to the inverter.



Safety Hint:

Before connection, please make sure the polarity of the output voltage of PV array matches the "DC+" and "DC-" symbols.



Safety Hint:

Before connecting inverter, please make sure the PV array open circuit voltage is within the 1000V of the inverter.



Pic 5.1 DC+ male connector (MC4)



Pic 5.2 DC- female connector (MC4)



Safety Hint:

Please use approved DC cable for PV system.

| Cable type | Cross section (mm ²) | |
|---|----------------------------------|-------------------|
| | Range | Recommended value |
| Industry generic PV cable (model: PV1-F) | 4.0~6.0 (12~10AWG) | 4.0(12AWG) |

Table 5.1 DC Cable Specifications

The steps to assemble the DC connectors are listed as follows:

a) Strip off the DC wire about 7mm, disassemble the connector cap nut (see picture 5.3).

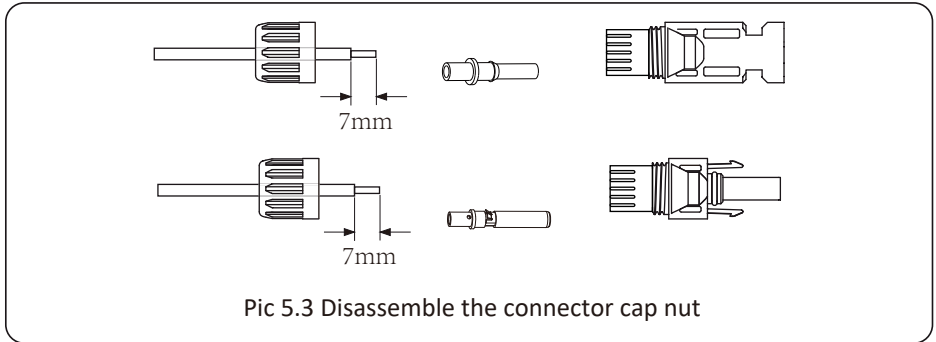

b) Crimping metal terminals with crimping pliers as shown in picture 5.4.



c) Insert the contact pin to the top part of the connector and screw up the cap nut to the top part of the connector. (as shown in picture 5.5).

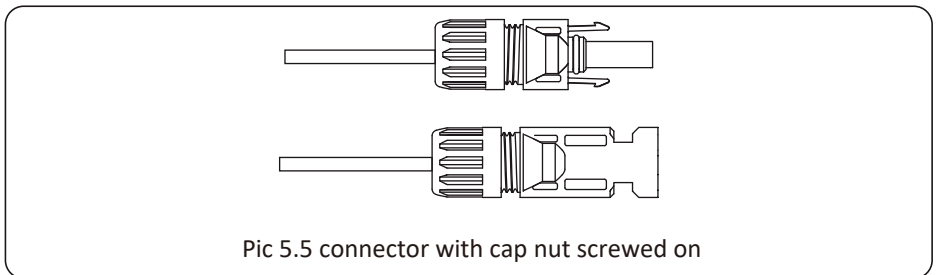

d) Finally insert the DC connector into the positive and negative input of the inverter, shown as picture 5.6

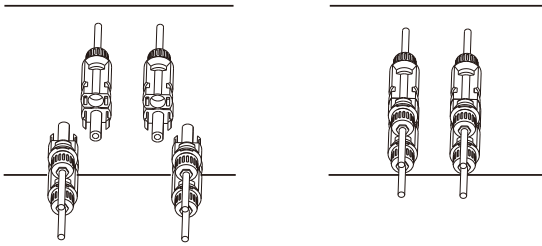

Pic 5.6 DC input connection



Warning: Sunlight shines on the panel will generate voltage, high voltage in series may cause danger to life. Therefore, before connecting the DC input line, the solar panel needs to be blocked by the opaque material and the DC switch should be 'OFF', otherwise, the high voltage of the inverter may lead to life-threatening conditions.



Warning: Use the DC power connector of the accessories. Do not interconnect the connectors of different manufacturers.

5.2 AC terminal connection

| Cable specifications | | Copper core cable |
|---|-------------------|-------------------|
| Conductor cross-sectional area (mm ²) | Recommended range | 25-50 |

Table 5.2 Recommended cable specifications



Warning: The AC cable line L1 is connected to socket 1; L2 is connected to socket 2; L3 is connected to socket 3, the PE line is connected to the earth , the N wire is connected to the socket of N.

AC wire production method is the same as that of 5.2.1.

AC wire installation method:

1) Remove the 8 fixing screws on the AC junction box of the inverter as shown in Pic 5.7. After removing the junction box, you can see the terminals of the inverter. The default is 5 digits as shown in Pic 5.8.

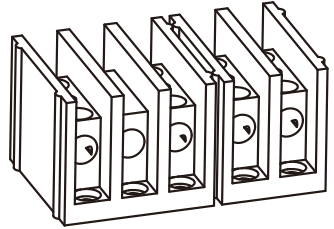
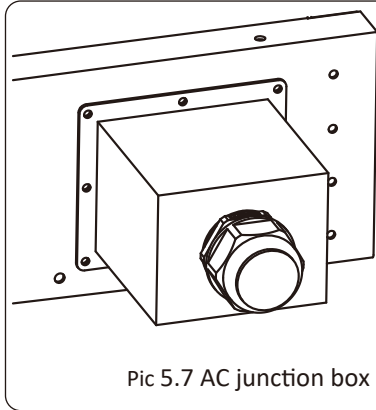

2) Connect the cable through the junction box, waterproof jacket, and insert into the terminal (The picture shows the connection mode of three phase lines connected to the junction box, ground wire screwed on the inverter shell) Pic5.9, and use hexagon screwdriver to presses the wiring harness to the connect terminal as shown in Pic5.10.

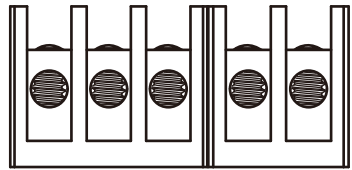
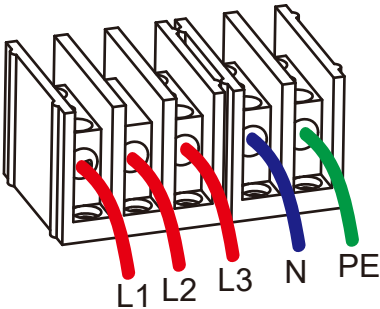

3) Screw the AC connection cover back to the shell and tighten all the screws to tighten the waterproof protection connector, as shown in Pic 5.11

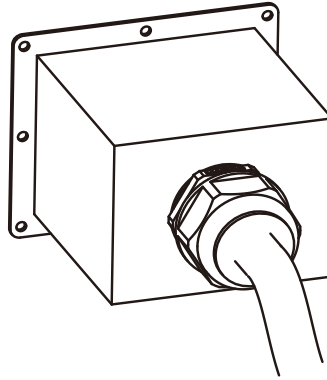

Pic 5.11 Tighten the AC junction box

5.2.3 Recommended current protector specifications

| Inverter | Rated voltage | Rated output power (KW) | Current protection device (A) |
|----------------|---------------|-------------------------|-------------------------------|
| SUN-25K-G02-LV | 127 | 25 | 75 |
| SUN-30K-G02-LV | 127 | 30 | 90 |

5.3 Connection of the ground line

Good grounded is important for resist the surge voltage shock and improve EMI's performance. So before the connection of AC, DC, communication connections, inverter needs to ground first. For a single system, just ground the PE cable; For multiple machine systems, all PE cables of the inverter need to be connected to the same grounding copper platoon to ensure the equipotent connection. The installation of the shell ground wire is shown as.

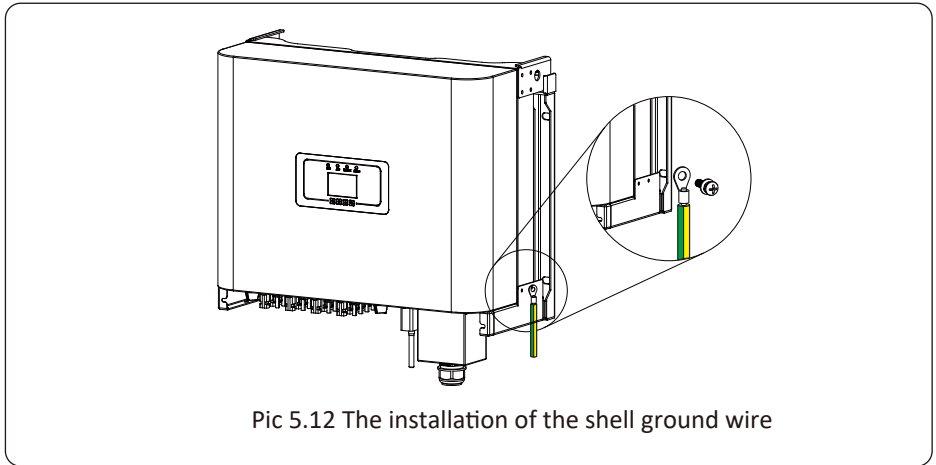

Warning:

Inverter has built-in leakage current detection circuit, If an external leakage current protection device is connected, its operating current must be greater than 300 mA or higher, otherwise inverter may not work properly.

5.4 Inverter monitoring connection

Inverter has the function of wireless remote monitoring inverter. The inverter has Wifi function and Wifi Plug in the accessories is used to realize the connection between the inverter and the network. The operation, installation, networking, APP download are detailed in the WIFI PLUG instructions. Figure 5.13 is the Internet monitoring solution.

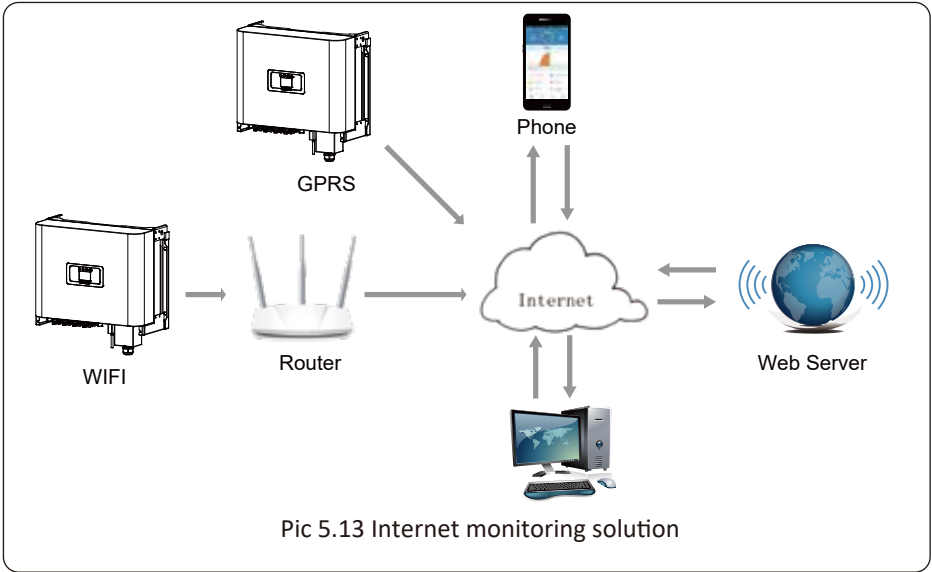

Pic 5.13 Internet monitoring solution

5.4.1 Installation of datalogger

When the inverter is out of the factory, the location of the installation of datalogger is sealed by a sealed plate as shown in Picture 5.14. When installing the datalogger, remove the sealing plate, replace it with the sealing plate with square hole in the accessories, and tighten the screws. Insert the datalogger into the interface and fix it with a screw. The configuration of the datalogger needs to be performed after various electrical connections have been completed and the inverter DC power on. When the inverter is on the DC power, it is determined whether the datalogger is normally electrified (The LED light shines out of the shell).

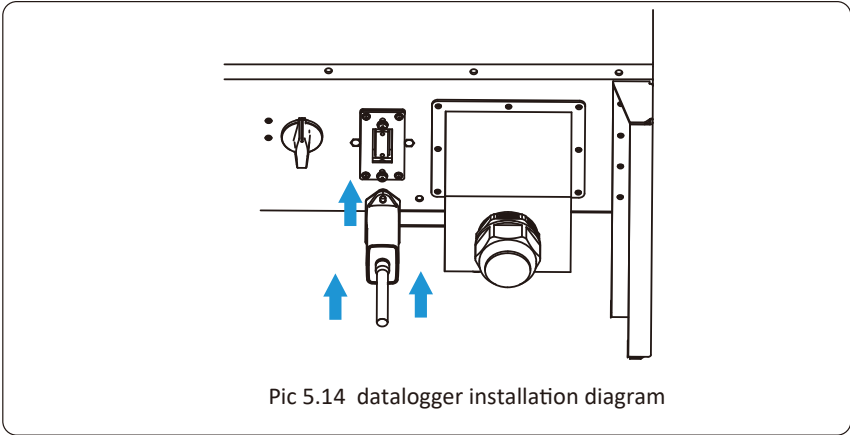

Pic 5.14 datalogger installation diagram

5.4.2 Configuration of datalogger

For the configuration of datalogger, please refer to illustrations of the datalogger.

6. Start up and Shut off

Ensure that the inverter meets the following conditions before starting the inverter, otherwise it may cause fire or damage to the inverter without quality assurance, at the same time the situation on our company does not undertake any responsibility. At the same time, to optimize the system configuration, it is recommended that the two inputs be connected to the same number of PV modules.

- a). The maximum open voltage of each set of PV modules shall not exceed 1000Vdc under any conditions.
- b). Each input of the inverter better use the same type of PV module in series.
- c). Total output power of pv shall not exceed the maximum input power of inverter, each PV modules shall not exceed the rated power of each channel.

6.1 Start up the inverter

When start up the inverter, should follow below steps:

1. First switch on the AC breaker.
2. Turn on the DC switch of the PV module, and if the panel provides sufficient starting voltage and power, the inverter will start.
3. When the AC voltage and DC voltage are normal, the inverter start-up is ready to begin. The inverter will first check the internal parameters and the grid parameters, while the liquid crystal will show that the inverter is self-checking.
4. If the parameter is within acceptable range, the inverter will generate energy. NORMAL indicator light is on.

6.2 Shut off the inverter

Must follow below steps while Shutting down the inverter:

1. Switch off the AC breaker.
2. Wait for 30 seconds, turn off the dc switch (if any), or simply disconnect the dc input connector. The inverter will close the LCD and all led within two minutes.

7.Zero export function via SUN limiter

The inverter has external zero export function. This function is optional. It can collect counter-current power to control the output power of the inverter, so that the power of inverter and load can be offset, and the excess power will not be fed back to the grid. If you purchase the inverter with zero export function, an external zero export device (SUN limiter or energy meter) will be included in the package which is necessary for the function. The SUN limiter shows as Pic 7.1. You can see corresponding line mark next to the green interface. The green terminals on the left are the interface of three-phase AC line (L1, L2, L3) and N Line (N), and the right are the interface between three sets of current sensor and one set of control terminals. SUN limiter will collect voltage and current from these interfaces and send control signals to the inverter.

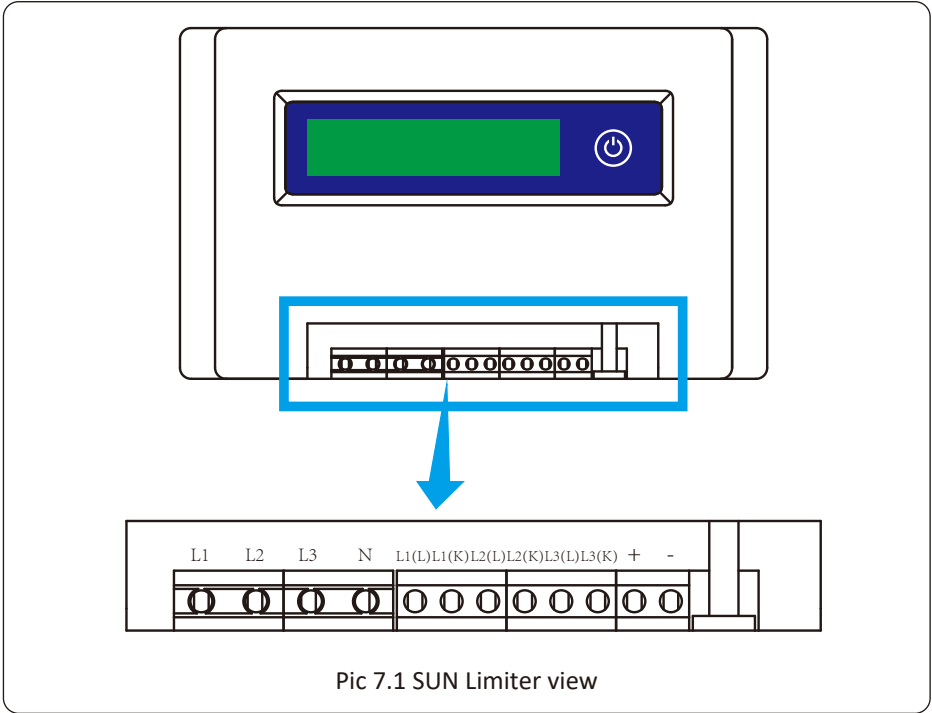

Pic 7.1 SUN Limiter view

7.1 SUN Limiter function wiring diagram

When you are reading this, we believe that you have completed the connection according to the requirements of chapter 5, if you have been running your inverter , and you want to use the limiter function, please turn off AC and DC switch of the inverter, and wait for 5 minutes until the inverter completely discharged.In order to make it easier for you to use the limiter function, we have specifically given the wiring diagram, as shown in Picture 7.2, the yellow/green/red live line (L1,L2,L3) connected to the utility grid live line (U/V/W), blue line means the neutral line.

We recommend installing an AC switch between the inverter outlet and the utility grid, the specs of the AC switch is determined by the load capacity. The AC switch we recommend to connect to the inverter output refer to Table 5.2.

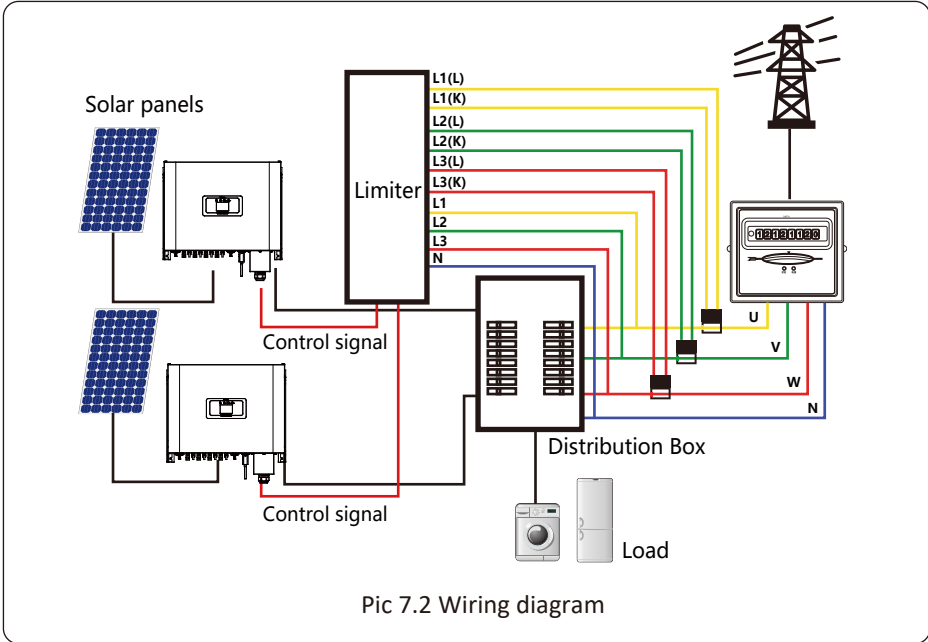

Pic 7.2 Wiring diagram

7.2 Connect the SUN limiter to inverter

The SUN limiter will measure the voltage and current of three phases separately, and this manual only introduces the installation steps of one phase, the other two phases are the same. The specific installation steps are as follows:

- (1) Connect SUN limiter to the grid. Connected to the grid is to measure the voltage of grid. Before connect to the grid, please turn off the switch to avoid the risk of electric shock. Choose one wire from the bottom of the three-phase DC switch. (any phase of U,V,W) to connect with L1 terminal, then tighten the line with a screwdriver.
- (2) Connect SUN limiter to clamp sensor. Clamp sensor can measure the current of the AC side, it should be connected to the front side of the load (domestic appliance ect.) to achieve this function. Only when the SUN limiter collects the voltage and current of the same phase can it judge the power of the phase. So the clamp sensor should be connected to the same phase as the before. Open the side buckle of the clamp sensor, then clamp the sensor to the AC line on the DC switch, the arrow direction on the sensor should towards that of the load. The clamp sensor has two lines (shown as below), and the white line corresponds to K terminal, black line corresponds to L terminal. Connect the white line to the L1(L) and L1(K) terminal refer to the line mark of the SUN limiter and tighten the line with screwdriver. This is the whole installation process of one phase.

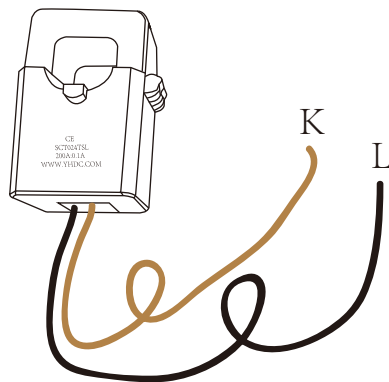

Pic 7.3 Clamp Sensor

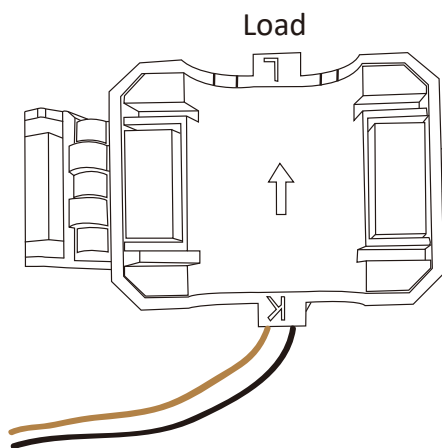

Pic 7.4 Clamp Sensor internal arrow

(3) After you finish the installation in process 1 and 2, connect the N line (N) to the N terminal of the limiter and tighten the line.

(4) Connect the control line. There are two numbers 1 and 2 on the interface of SUN limiter, and the same on the waterproof terminal of the inverter. Twist the waterproof terminal and connect the red line to number 1 and black line to number 2 shown as the picture. After that connect the terminal to the interface of the SUN limiter. The other side of the line should be connected to the control terminal.

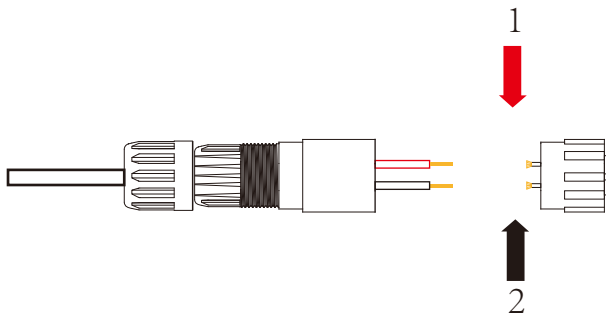

Pic 7.5 Waterproof terminal

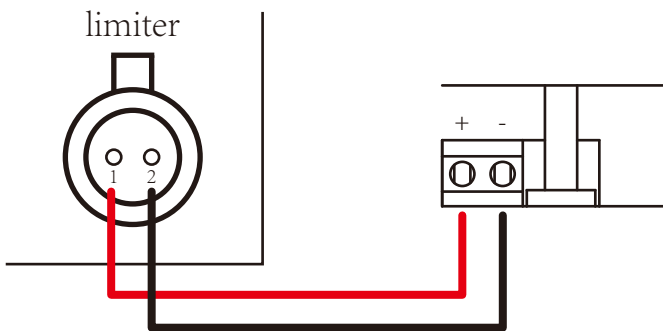

Pic 7.6 Connect SUN limiter to inverter

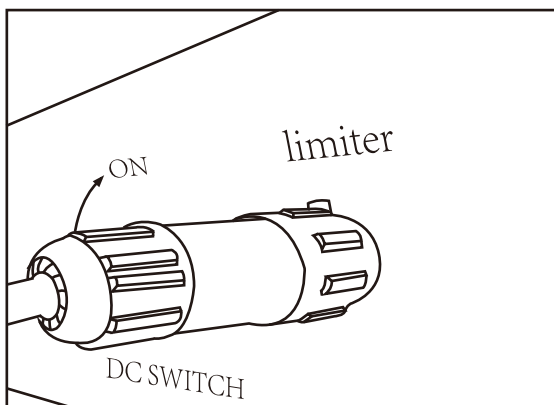

Pic 7.7 Connect terminal to inverter

7.3 Debugging Limiter

Turn on the anti-backflow function of the inverter refer to the manual , then turn on the limiter's power supply, and last turn on the inverter.

Press the button of the limiter to the setting interface. Long press the button to switch the anti-backflow mode. The limiter has two anti-backflow modes, the minimum mode and the average mode. In the minimum mode, the limiter will control the power of the inverter according to the phase with the lowest power to ensure that no reverse current will occur in each phase. In average mode, The limiter controls the output of the inverter according to the average of the total power of the three-phase load, which may cause single backflow. The controller is produced in the minimum mode to ensure no anti-backflow happens to the customers.

When the connection is completed, the following steps should be referenced to use this function:

1. Turn on the AC switch.
2. Turn on the DC switch, Waiting inverter LCD lighting up.
3. Press Enter button on the LCD panel in the main interface into the menu options, select [parameter setting] to Enter setup submenu, and then select [run param], at this time please Input the default password 1234 through pressing the button [up down, confirm], enter the operation parameter setting interface, Shown as figure:

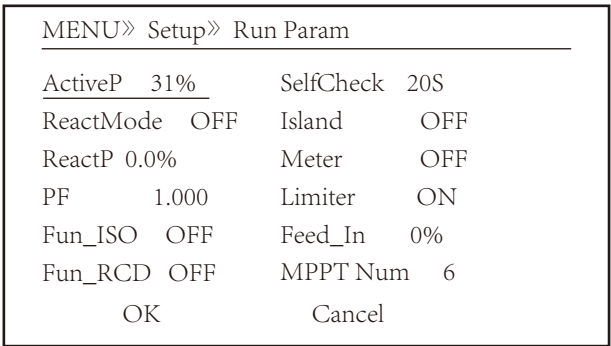

| | | | |
|------------------------|-------|-----------|-----|
| MENU» Setup» Run Param | | | |
| ActiveP | 31% | SelfCheck | 20S |
| ReactMode | OFF | Island | OFF |
| ReactP | 0.0% | Meter | OFF |
| PF | 1.000 | Limiter | ON |
| Fun_ISO | OFF | Feed_In | 0% |
| Fun_RCD | OFF | MPPT Num | 6 |
| OK | | Cancel | |

Pic 7.8 Zero-export function via SUN limiter setting interface

4. Operate the button [up down], move setting cursor to limit function and press the button [enter]. At this time you can turn on or turn off the limit function by choosing [up down] button, please press [enter] button to confirm when setting done.
5. Move the cursor to [confirm] , press ENTER to save the settings and exit the running parameters page, otherwise the settings are invalid.
6. If set up successfully, you can return to the menu interface, and display the LCD to [home page] by press the [up down] button. If it displayed as [utility power], the limiter function settings will be completed. Shown as picture 7.9.

| RUN | Grid |
|---------------------|-----------|
| Ua : 234.5V | Ia : 0.0A |
| Utility Power: 0W | |
| Grid Freq : 50.00Hz | |

Pic 7.9 Limiter function turn on

[utility power] showing positive means grid power is providing power to the load consuming energy, and there is no PV energy flow to grid. If [utility power] shows negative, which means there's excess PV energy flows to grid or current transformer arrow direction is in wrong direction. Please read more on chapter 7.9.

7.4 Zero-export function (Option)

The string inverter supports zero-export function via Energy meter / SUN-Limiter. Based on continuously data communication, once the Limiter or energy meter detects power export to the grid, it will send the information to the inverter and then inverter will ramp down its active power according to match the load demand and achieve zero export. The Zero-export function is optional. If you buy the inverter with zero-export function via energy meter, energy meter will be included in the package which is necessary for zero-export function.

7.4.1 Zero-export function via energy meter

There're two kinds of energy meters for this series inverter. First type is Eastron SDM630-Modbus V2 which is able to measure the Max. 100A current directly. More details please refer to Pic 7.10 & 7.11. For the Eastron SDM630 MCT 40mA, it needs external CT to measure the current. The CT power range is from 5A-2000A. More details about the Eastron SDM630 MCT, please refer to Pic 7.12 & 7.13. Also, the CHNT meter DTSU666 is supported, it can measure the Max. 80A current directly. More details about the DTSU666, please refer to Pic 7.14 & 7.15.

When you are reading this, we believe that you have completed the connection according to the requirements of chapter 5, if you have been running your inverter at this time, and you want to use the zero-export function, please turn off AC and DC switch of the inverter, and wait for 5 minutes until the inverter completely discharged.

For system wiring diagram, the red line refers to L line (L1, L2, L3), the black line refers to the neutral line (N). Connecting energy meter RS485 cable to inverter's RS485 port. It's recommended to install an AC switch between the inverter and the utility grid, the specs of the AC switch are determined by the power of load.

If there is no integrated DC switch inside the inverter you purchased, we commend you to connect the DC switch. The voltage and current of the switch depend on the PV array you access.

| MENU» Setup» Run Param | | | |
|------------------------|-------|-----------|-----|
| ActiveP | 0% | SelfCheck | 20S |
| QMode | OFF | Island | OFF |
| ReactP | 0.0% | Meter | ON |
| PF | 1.000 | Limiter | OFF |
| Fun_ISO | OFF | Feed_In | 0% |
| Fun_RCD | OFF | MPPT Num | 0 |
| OK | | Cancel | |

Pic 7.10 Meter function turn on

If you want to use zero output mode, please set Meter to ON and select OFF to view data only

| MENU Setting | |
|--------------|------|
| CT_Ratio | 0 |
| Exp_Mode | MIN |
| MFR | AUTO |
| Back | |

Pic 7.11 Meter function

Exp_Mode: AVG or Min .

AVG:The output power of the inverter is equal to the total load power.

Min:The output power of the inverter ensures that the smallest phase of the three phases does not output power, and the total output power is the minimum phase load power *3 , For example, A: 1KW B: 2KW C: 3KW,LoadTotal power:6KW,then the inverter output power is 1KW*3=3KW , Power consumption of the grid is 3KW.

CT_Ratio: CT ratio of power grid meter , Set this parameter only when an ammeter with an external current sensor is used. The setting must be consistent with the actual CT ratio; otherwise, inaccurate data will be obtained.

MFR: power grid meter. Select the manufacturer according to the actual use , The address must be set to 001.

Feedin:The extra power output after the load power is satisfied

Shunt: MST, SLV or OFF. When there are multiple machines, only one can be set as the master machine and the others as slave machines.

ShuntQty: Number of parallel connections, including main machines.

Generator:ON/OFF.

G.CT: CT ratio of power Generator meter , Set this parameter only when an ammeter with an external current sensor is used. The setting must be consistent with the actual CT ratio; otherwise, inaccurate data will be obtained.

G.MFR: power Generator meter. Select the manufacturer according to the actual use, The address must be set to 002.

G.feedin: The power output allowed by the generator, in proportion to the generator capacity.

G.Cap:G.cap: generator capacity, set upper limit 999KW.

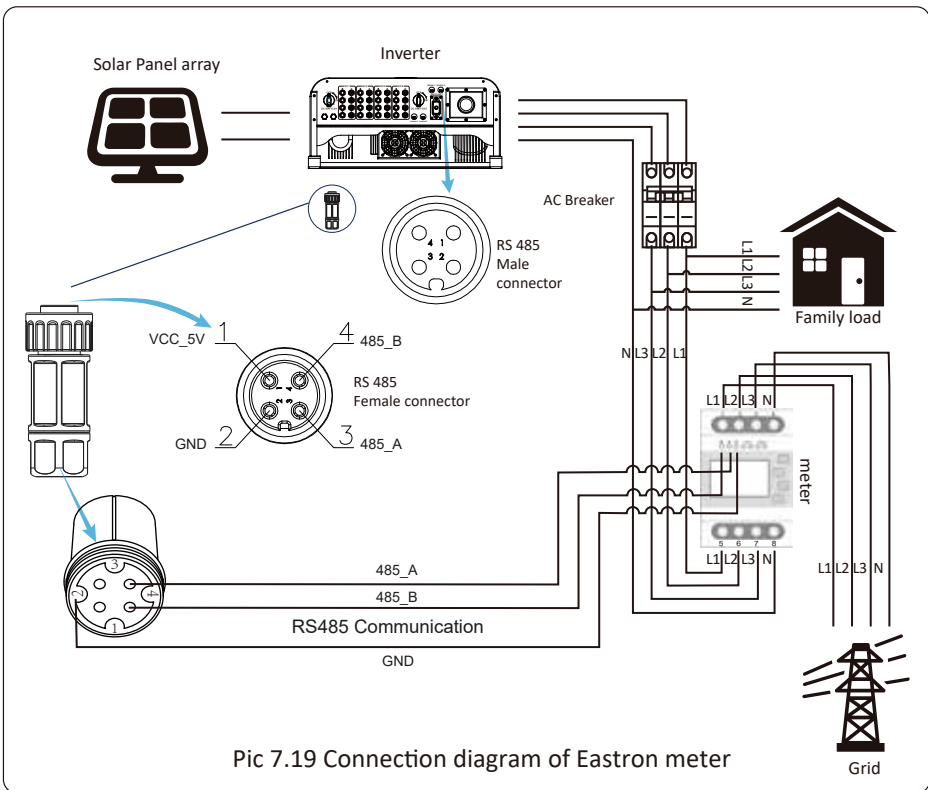
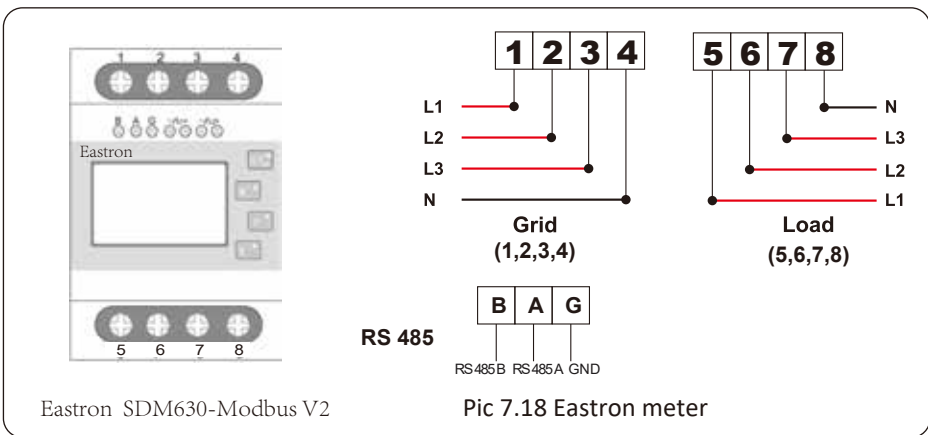

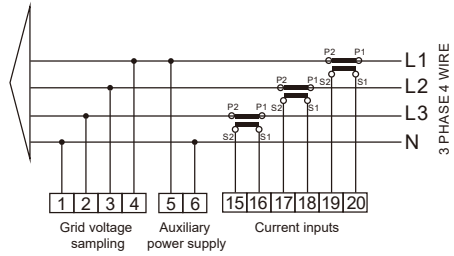
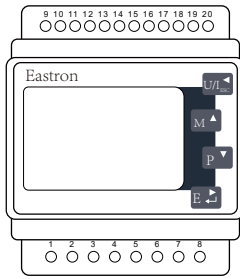

RS 485

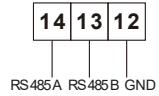

Eastron SDM630MCT Pic 7.20 Eastron meter

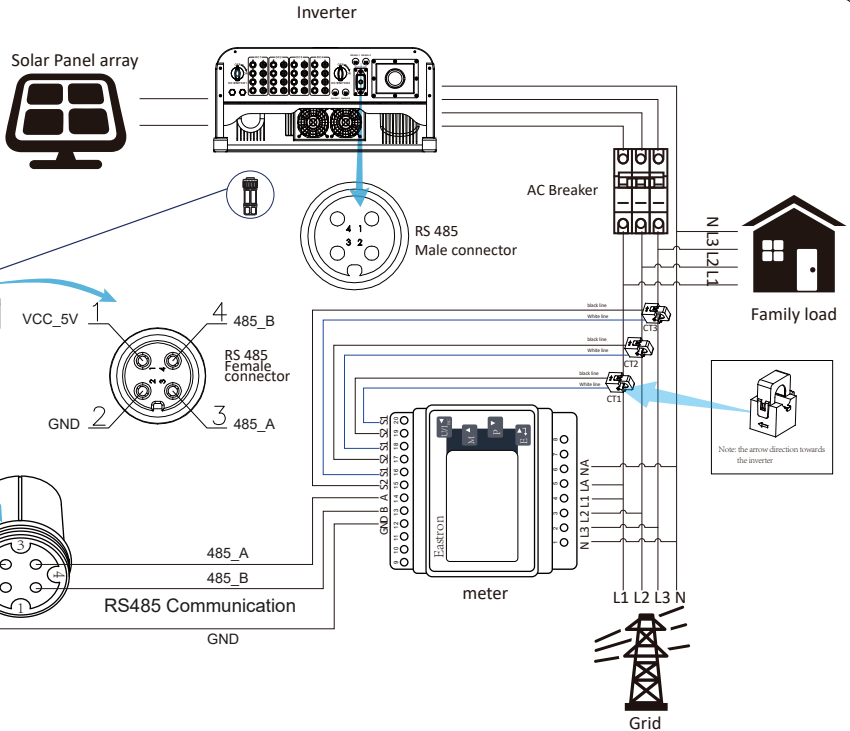

Pic 7.21 Connection diagram of Eastron meter

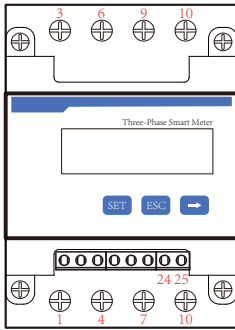

CHINT DTSU666

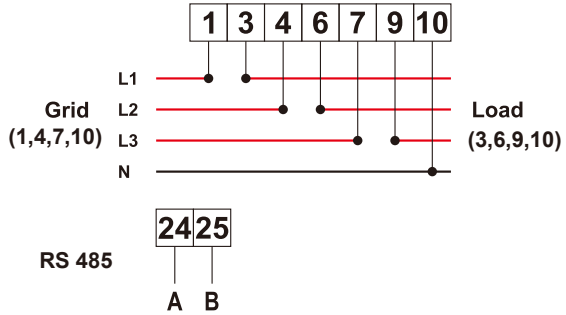

Pic 7.22 CHINT meter

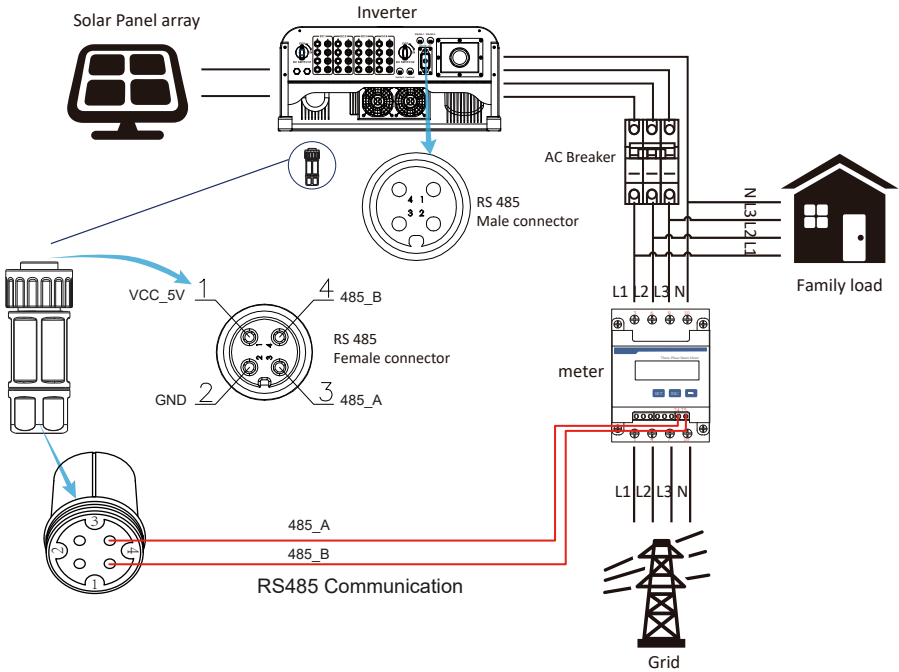

Pic 7.23 Connection diagram of CHINT meter



Warning:

Ensuring grid input cables connect 1/4/7/10 port of energy meter, and inverter AC output cables connect 3/6/9/10 port of energy meter when connecting.

3. Press Enter button on the LCD panel in the main interface into the menu options, select [parameter setting] to enter setup submenu, and then select [run param], at this time please input the default password 1234 through pressing the button [up down, enter], enter the operation parameter setting interface, shown as picture 7.24.

| | | | |
|------------------------|-------|-----------|-----|
| MENU» Setup» Run Param | | | |
| ActiveP | 31% | SelfCheck | 20S |
| QMode | QU | Island | OFF |
| ReactP | 0.0% | Meter | ON |
| PF | 1.000 | Limiter | OFF |
| Fun_ISO | ON | Feed_In | 0% |
| Fun_RCD | ON | MPPT Num | 6 |
| OK | | Cancel | |

Pic 7.24 Zero-export function via meter setting interface

- Operate the button [up down], move setting cursor to energy meter and press the button [enter]. At this time you can turn on the energy meter by choosing [up down] button, please press [enter] button to confirm when setting done.
- Move the cursor to [OK], press [enter] to save the settings and exit the running parameters page, otherwise the settings are invalid.
- If set up successfully, you can return to the menu interface, and display the LCD to [home page] by press the [up down] button. If it displays [meter power XXW], the zero-export function setting is completed. Shown as picture 7.25.

| | | |
|--------------|----------|-----------|
| PARAMETR | Meter | |
| | SN:1 | |
| Meter Power: | 428W | |
| Load Power: | 1.043kW | |
| | Day | Total |
| ImpEp : | 9.51kWh | 2.24MWh |
| ExpEp : | 0.00kWh | 574.75KWh |
| LoadEp : | 13.71kWh | 1.67MWh |

Pic 7.25 Zero-export function via energy meter turn on

- Meter power 428W shows positive means grid is supplying the load, and no power fed into grid. if meter power shows negative, it means PV energy is being sold to grid or energy meter wiring connection has problem.
- After properly connection is done, wait for inverter starting. If the power of the PV array meets the current power consumption, the inverter will keep a certain output to counteract the power of the grid without backflow .

7.5 Notes while using zero export function

For your safety and the operation of limiter function of the inverter, we put forward the following suggestions and precautions:



Warning:

Under zero export mode we strongly recommend that the two PV arrays are formed by the same number of PV panels of the same size, which will make the inverter more responsive to limit the power.



Safety Hint:

While the utility power is negative and inverter has no output power, that means the orientation of the current sensor is wrong, please turn off the inverter and change orientation of the current sensor.

(when using SUN limiter, the arrow of current sensor points to the load)



High Temperature Hazard:

When using SUN limiter, the current sensor of limiter function needs to be clamped on the fire line of the grid connected to the inverter, otherwise inverter cannot able to normal operate.

7.6 How to browse the load power of your PV grid-tie plant on monitoring platform?

If you want to browse load power of the system and how much energy (KWH) does it export to grid (inverter output power is used to power the load firstly and then the surplus energy will feed into grid). You also need to connect the meter according to above diagram. After the connection completed successfully, the inverter will show the load power on the LCD. **But please don't setup "Meter ON"**. Also, you will be able to browse the load power on the monitoring platform. The plant setting method as below description.

Firstly, go to the solarman platform (<https://pro.solarmanpv.com>, this link is for solarman distributor account; or <https://home.solarmanpv.com>, this link is for solarman end user account;) plant home page and click "edit"



And then choose your system type as “Self-consumption”

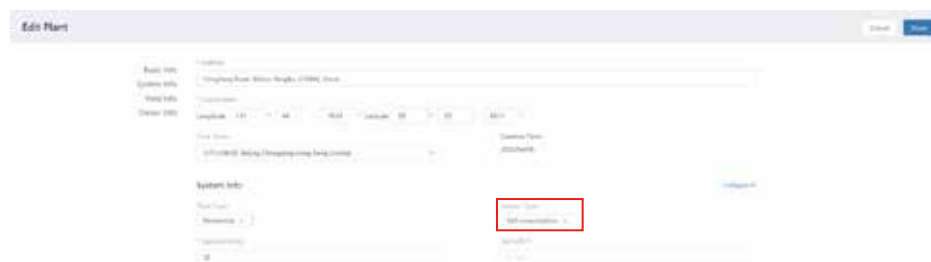

Secondly, go to plant page, if it shows the PV power, load power and grid power, which means the configuration is correct.



8. General Operation

During normal operation, the LCD shows the current status of the inverter, including the current power, total generation, a bar chart of power operation and inverter ID, etc. Press the Up key and the Down key to see the current DC voltage, DC current, AC voltage, AC current, inverter radiator temperature, software version number and Wifi connection state of the inverter.

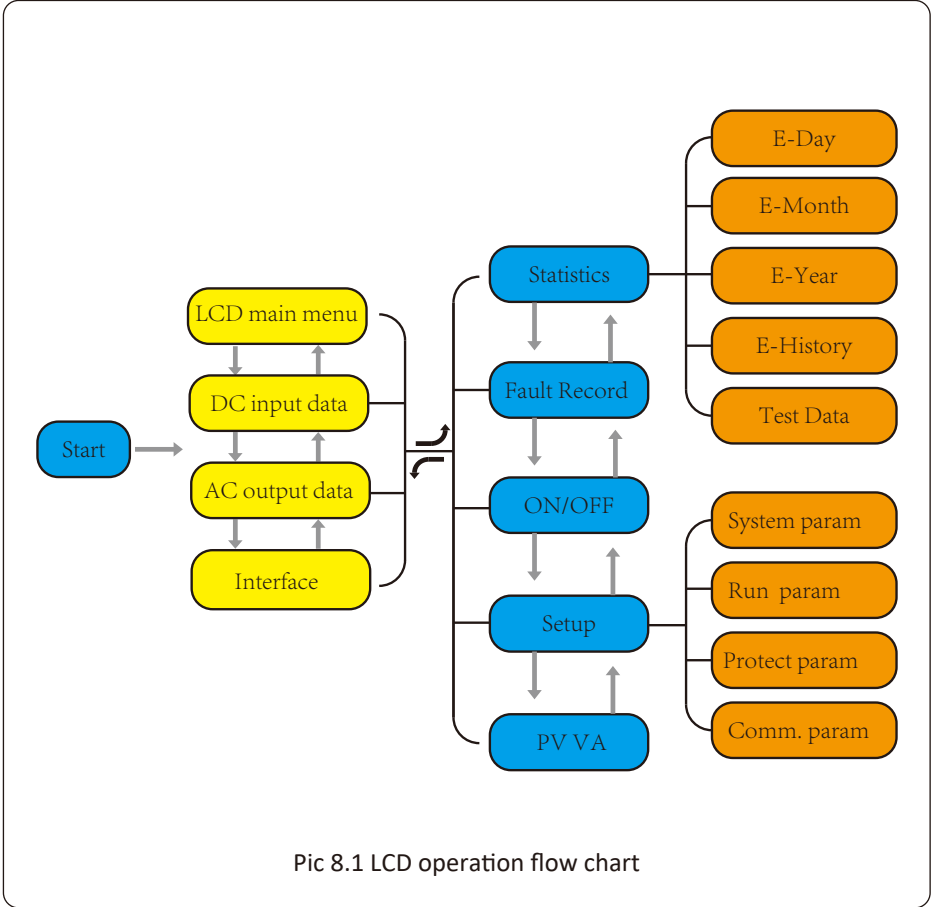

Pic 8.1 LCD operation flow chart

8.1 The initial interface

From the initial interface, you can check power, day power, total power, inverter ID , model and time.

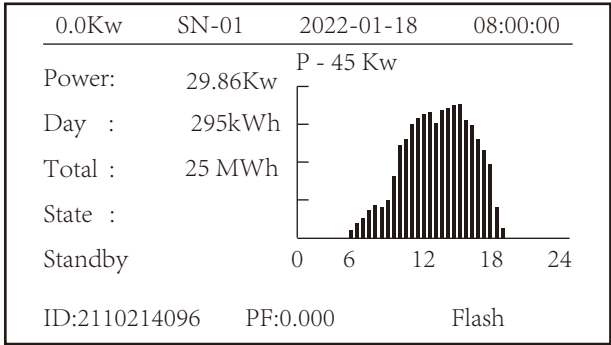

Pic 8.1 The initial interface

Press UP or Down you can check inverter DC voltage, DC current, AC voltage, AC current, inverter temperature, software version information.

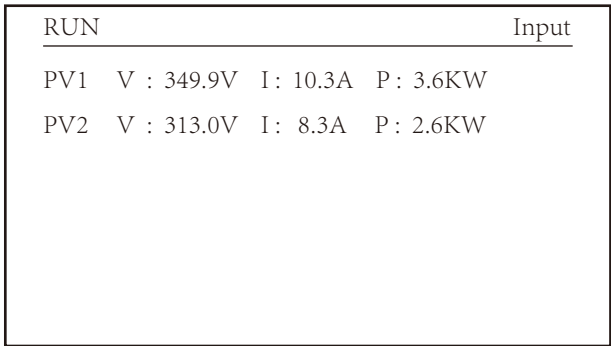

Pic 8.2 PV input and DC current information

You can check the PV information, the number of strings input, MPPT voltage and MPPT current.

| | |
|---------------------|-----------|
| RUN | Grid |
| Ua : 234.5V | Ia : 0.0A |
| Grid Freq : 50.00Hz | |

Pic 8.3 AC running state information

You can check the three phase voltage, current, and grid frequency.

| |
|---|
| RUN |
| Total DC Power: |
| 3.602W |
| Lcd0d94 Inv1400 |
|  |

Pic 8.4 Inverter firmware version

You can check the inverter LCD software Ver0166 and Control Software Version Ver1860. There are two black spot in the bottom right corner. The first flash means inverter is communicating with LCD. The second flash means LCD is communicating with wifi plug.

| PARAMETR | Meter |
|------------------|---------|
| | SN: 0 |
| Meter Power: 0W | |
| Load Power: 0W | |
| | Total |
| ImpEp : 0.00kWh | 0.00kWh |
| ExpEp : 0.00kWh | 0.00kWh |
| LoadEp : 0.00kWh | 0.00kWh |

Pic 8.5 Meter power and load power

8.1.1 Main Menu

There are four submenu in the Main Menu.

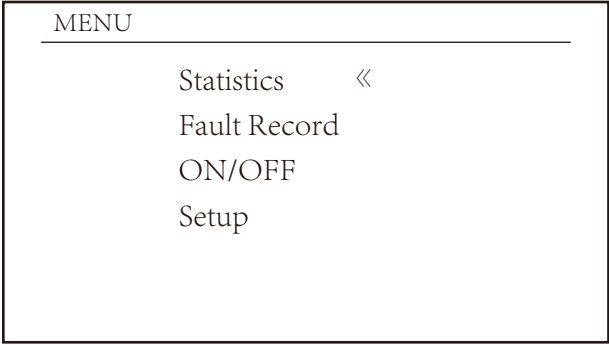

Pic 8.5 Main Menu

8.2 Statistics information

There are five submenu in the statistics.

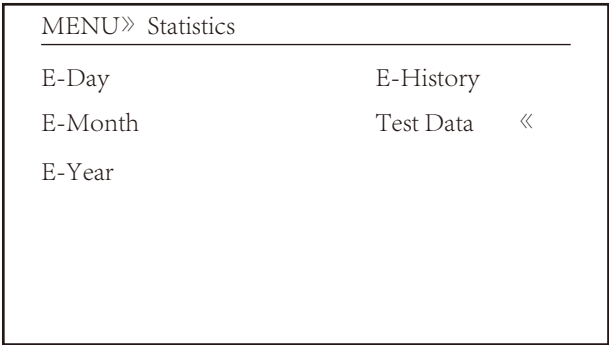

Pic 8.6 Statistics

Into each submenu through cursor.

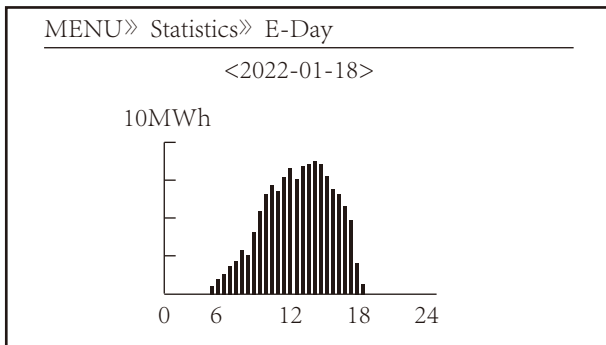

Pic 8.7 E-Day

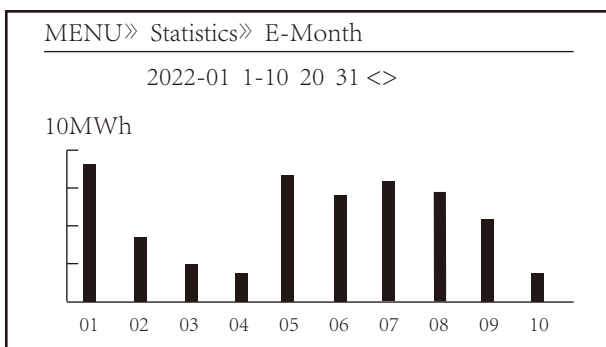

Pic 8.8 E-Month

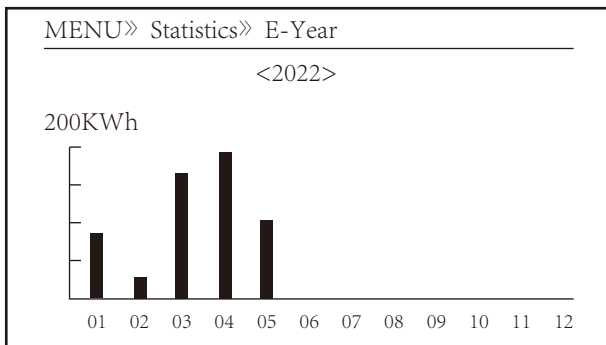

Pic 8.9 E-Year

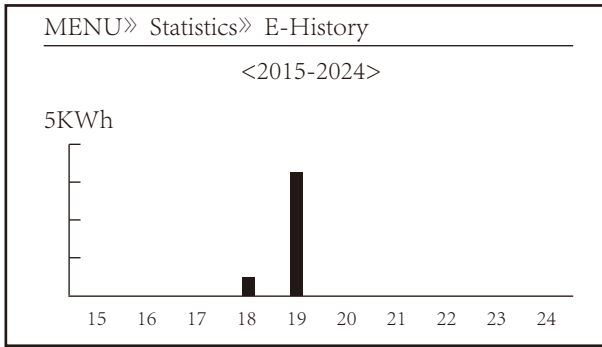

Pic 8.10 E-History

This information is for technician's reference.

| | | | | | |
|-------|-------|-------|-------|-------|------|
| PV1 : | 19186 | 1k3 : | 11126 | ofC : | 2057 |
| PV2 : | 19198 | 1k4 : | 11140 | 137 : | 2145 |
| HV : | 24362 | 1k5 : | 16666 | 138 : | 2248 |
| GFD : | 9119 | 1k6 : | 2927 | 139 : | 1497 |
| DiL : | 36 | vHV : | 24362 | 140 : | 0 |
| AVL : | -2 | BSn : | 12218 | 141 : | 0 |
| 126 : | 287 | ofA : | 2065 | 142 : | 0 |
| 1k2 : | 6 | ofB : | 2653 | 143 : | 0 |
| 146 : | 0 | 148 : | 0 | 144 : | 0 |
| 147 : | 0 | 149 : | 0 | 145 : | 0 |

Pic 8.11Test Data

8.3 Fault Record

Only can keep four fault record in the menu include time, customer can deal with it depends on the error code.

MENU» Fault Record

| | |
|-------------|---------------------|
| Fault : | F352022-01-05 08:38 |
| History : 1 | F352022-01-05 08:37 |
| 2 | F352022-01-04 18:47 |
| 3 | F352022-01-04 17:54 |
| 4 | F352022-01-04 17:53 |

Pic 8.12 Fault Record

8.4 ON/OFF setting

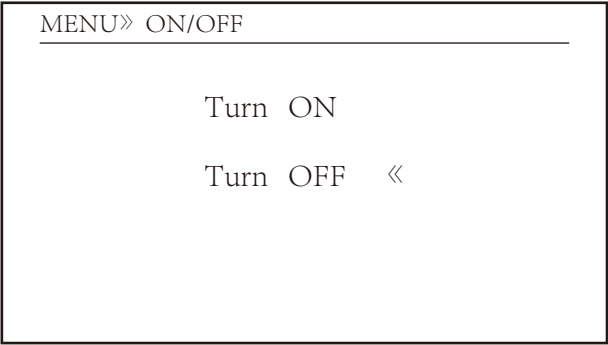

Pic 8.13 ON/OFF setting

Into each submenu through cursor.

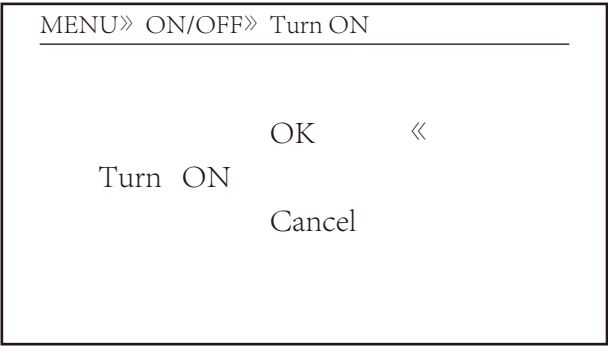

Pic 8.14 ON set

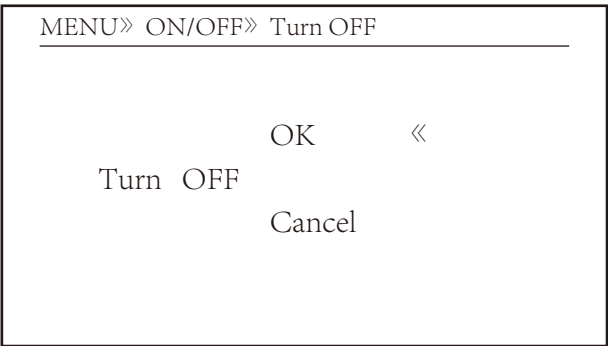

Pic 8.15 OFF set

8.5 Parameter setting

Setting includes system param, run param, protect param, comm.. param. All of these information for maintenance reference.

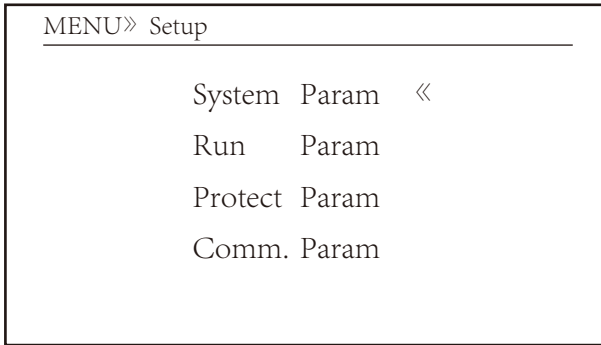

Pic 8.16 Setting

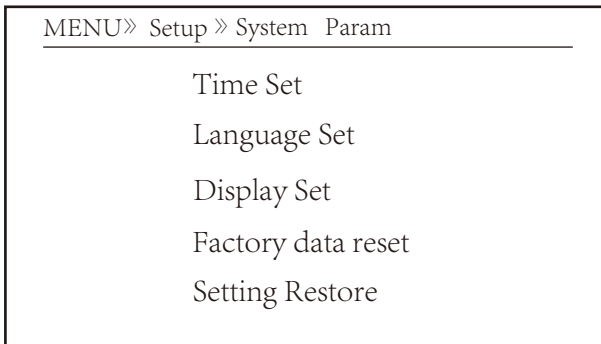

Pic 8.16.1 System Param Setting

8.5.1.2 Time Set

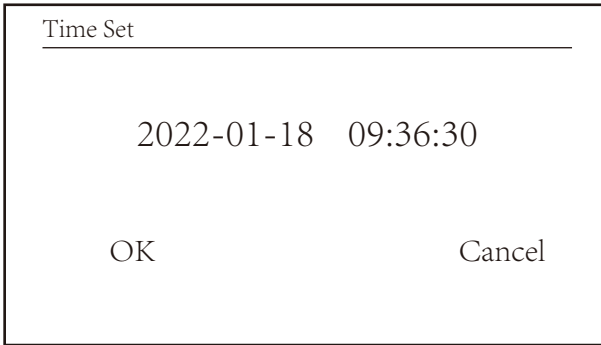

Pic 8.18 System Param

8.5.1.3 Language Set

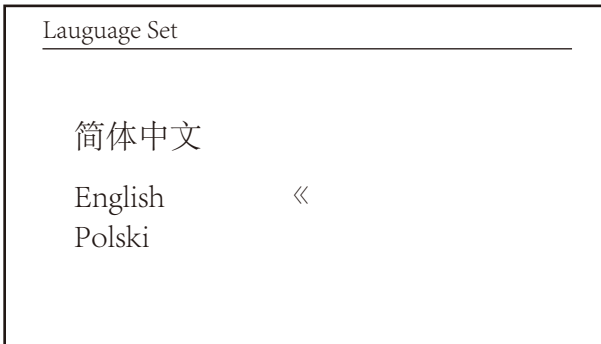

Pic 8.19 Language set

8.5.1.4 Display Set

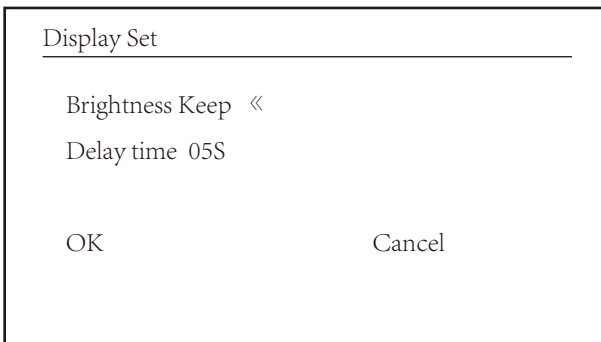

Pic 8.20 Display set

8.5.1.5 Factory data reset

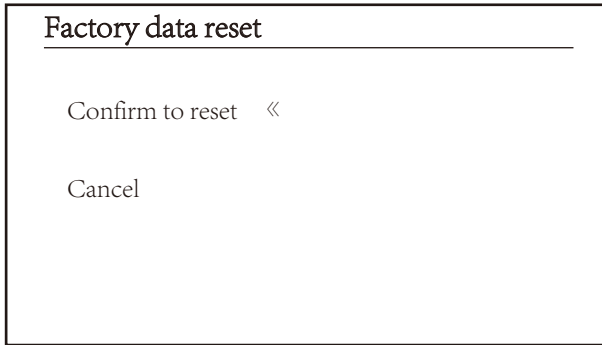

Pic 8.21 Factory data reset set

8.5.1.6 Setting Restor

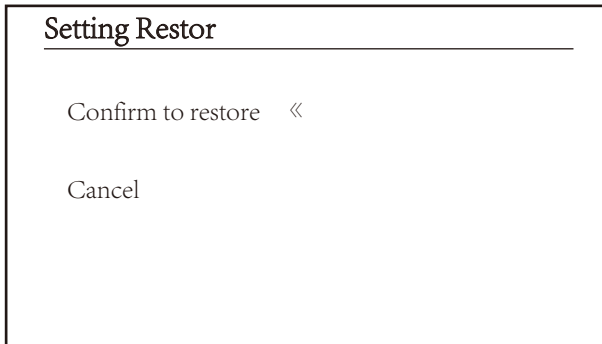

Pic 8.22 Factory data reset set



Note:

Password required-- only for access-authorized engineer. Un-authorized access may avoid the warranty. The initial password is 1234.

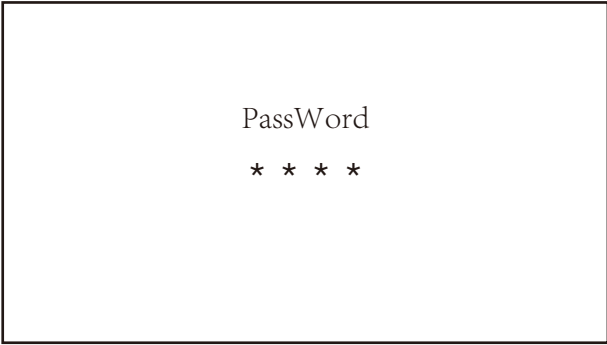

Pic 8.22 Password

MENU» Setup» Run Param

| | | | |
|-----------|-------|-----------|--------|
| ActiveP | 31% | SelfCheck | 20S |
| ReactMode | OFF | Island | OFF |
| ReactP | 0.0% | Meter | ON |
| PF | 1.000 | Limiter | OFF |
| Fun_ISO | OFF | Feed_In | 0% |
| Fun_RCD | OFF | MPPT Num | 6 |
| | OK | | Cancel |

ActiveP Adjust the output active power in %

ReactMode Reactive Mode Switch

ReactP Adjust reactive power output in %

PF Power factor

| | |
|---|---|
| Fun_ISO | Insulation resistance detection |
| Fun_RCD | Residual current detection |
| Self-check | Inverter's self-check time.The default value 60s |
| Island | Anti-islanding protection |
| Meter | Energy meter.If inverter will connect meter,then set here to ON |
| Limiter | If inverter will connect SUN limiter,then set here to ON |
| Feed_IN % | it is used to deploy how much power can be feed into grid. |
| <p>For example, Feed_in=50% of the 60KW model, which means Max. 30KW .power can be feed into grid. And, this parameter is valid only after connecting a meter and the meter function is "ON".</p> | |

Pic 8.23 Running Param



Note:

Engineer Only.

We will set the param depends on the safety requirements, so customers don't need to reset it. The password is same as 8.23 Running param

| | | | |
|------------------------|------|--------|------|
| MENU» Setup» Run Param | | | |
| ARC | OFF | Vref | 0.0V |
| OFDerate | OFF | | |
| UFUprate | OFF | | |
| PU | OFF | | |
| WGra | 0.0% | | |
| Sunspec | OFF | | |
| OK | | Cancel | |

| NAME | DESCRIPTION | RANGE |
|----------|--|----------------------------|
| ARC | Arc-fault detection function | ON/OFF/Clear |
| OFDerate | Power decreases as frequency increases | 0-100% Pmax/Hz |
| UFUprate | Power increases as frequency decreases | 0-100% Pmax/Hz |
| PU | Power varies with voltage | 0-150% Vref 0-110% Pmax |
| WGra | Adjust active power output in % | [100, 50000] 0.1%-50% |
| Sunspec | turn on/turn off the Sunspec communication | ON/OFF/Clear |

| | | | | | |
|------------------------|---------|---------|--------|---|--|
| MENU» Setup» Run Param | | | | | |
| 1: OFF | 7: OFF | 13: OFF | A: | 0 | |
| 2: OFF | 8: OFF | 14: OFF | B: | 0 | |
| 3: OFF | 9: OFF | 15: OFF | C: | 0 | |
| 4: OFF | 10: OFF | 16: OFF | D: | 0 | |
| 5: OFF | 11: OFF | | E: | 0 | |
| 6: OFF | 12: OFF | | F: | 0 | |
| OK | | | Cancel | | |

8.5.2 Over-frequency Response

This series inverter provides “over-frequency response” function.
Long pressing the “OFD Derate” to enter the “over-frequency response” setting menu.

| | | | |
|------------------------|-------|--------|--------|
| MENU» Setup» Run Param | | | |
| ARC | OFF | Vref | 220.0V |
| OFDerate | ON | | |
| UFUprate | OFF | | |
| PU | OFF | | |
| WGra | 20.0% | | |
| Sunspec | OFF | | |
| | OK | Cancel | |

Definition of Over-frequency Response Parameters

| Parameter | Range | Description |
|-----------------|---------------------|--|
| StartPoint | 45HZ-65HZ | The Start frequency value for over-frequency response. |
| StopPoint | 45HZ-65HZ | The Stop frequency value for over-frequency response. |
| RecoverPoint | 45HZ-65HZ | In hysteresis mode, power is restored only when it is below this frequency |
| RecoverGradient | [3,500] 0.01%Pmax/s | Rate of Power recovery(Percentage of active power) |

For example, StartPoint: 50.5Hz, StopPoint: 51.5Hz, RecoverPoint: 50.1Hz, when the grid frequency increases beyond StartPoint : 50.5Hz, the inverter will linearly reduce the power output with a gradient of 100% Pmax/Hz until it reaches StopPoint: 51.5Hz .

| | |
|---------------------|---------|
| OverFrequencyDerate | |
| StartPoint | 50.50Hz |
| StopPoint | 51.50Hz |
| RecoverPoint | 50.1Hz |
| RecoverGradient | 1.00% |
| Back | |

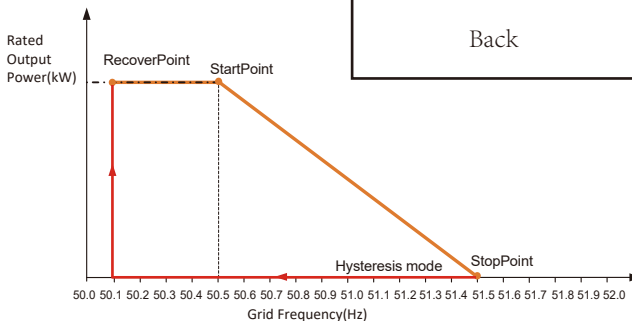

Frq-Watt Mode for Over-frequency Conditions

When the frequency exceeds StopPoint: 51.5Hz, the inverter output should stop (ie 0 W).
 When the frequency is lower than StopPoint: 51.5 Hz, the inverter will linearly increase the power output with a gradient of 100% Pmax/Hz until it reaches StopPoint: 50.5 Hz.
 In the hysteresis mode, when the frequency is lower than StopPoint: 51.5 Hz, the inverter will not increase the power output until it is lower than RecoverPoint: 50.1 Hz.

| | | | |
|------------------------|-------|-----------|--------|
| MENU» Setup» Run Param | | | |
| ActiveP | 31% | SelfCheck | 20S |
| QMode | QU | Island | OFF |
| ReactP | 0.0% | Meter | ON |
| PF | 1.000 | Limiter | OFF |
| Fun_ISO | ON | Feed_In | 0% |
| Fun_RCD | ON | MPPT Num | 6 |
| | OK | | Cancel |

The inverter provides a reactive power regulation function.
 Tap **Reactive Power Regulation Mode** to select proper regulation mode and set the corresponding parameters.

- **"OFF" Mode**
 The reactive power regulation function is disabled. The PF is fixed at +1.000
- **ReactiveP**
 Adjust reactive power output in %.
- **"PF" Mode**
 The power factor (PF) is fixed and the reactive power is regulated by the parameter PF. The PF ranges from 0.8 leading to 0.8 lagging.
 - Leading: the inverter is sourcing reactive power to the grid.
 - Lagging: the inverter is injecting reactive power into the grid.
- **"Q(U)" Mode**
 The reactive power output of the inverter varies in response to the grid voltage.
- **"Q(P)" Mode**
 The reactive power output by the inverter is controlled by the active power of the inverter.

“Q(U)” Mode

| QU Setting | |
|------------|-------|
| Start | 30.0% |
| Stop | 20.0% |
| RmpTime | 2s |
| PtUsage | 4 |
| Points | |
| Back | |

| QU Setting | | | |
|------------|--------|----|--------|
| V1 | 80.0% | Q1 | -25.0% |
| V2 | 90.0% | Q2 | 0.0% |
| V3 | 110.0% | Q3 | 0.0% |
| V4 | 120.0% | Q4 | 25.0% |
| V5 | 120.0% | Q5 | 25.0% |
| V6 | 120.0% | Q6 | 25.0% |
| Back | | | |

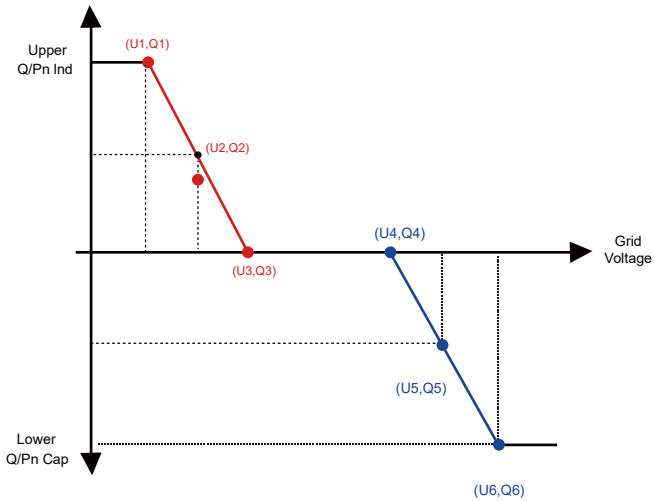

Pic 8.24 Reactive Power Regulation Curve in Q(U) Curve

| parameter | Range | description |
|-----------|------------------------|--|
| QU_Start | 0%-130% Rate out power | The QU mode starts when the active power is greater than this value |
| QU_Stop | 0%-130% Rate out power | The QU mode stops when the active power is less than this value |
| Q1 | -60% -60% Q/Pn | Value of Q/Pn at point (U1,Q1) on the Q(U) mode curve |
| V1 | 0-110% VRated | Grid voltage limit at point (U1,Q1) on the Q(U) mode curve |
| Q2 | -60% -60% Q/Pn | Value of Q/Pn at point (U2,Q2) on the Q(U) mode curve |
| V2 | 0-110% VRated | Grid voltage limit at point (U2,Q2) on the Q(U) mode curve |
| Q3 | -60% -60% Q/Pn | Value of Q/Pn at point (U3,Q3) on the Q(U) mode curve |
| V3 | 0-110% VRated | Grid voltage limit at point (U3,Q3) on the Q(U) mode curve |
| Q4 | -60% -60% Q/Pn | Value of Q/Pn at point (U4,Q4) on the Q(U) mode curve |
| V4 | 0-110% VRated | Grid voltage limit at point (U4,Q4) on the Q(U) mode curve |
| Q5 | -60% -60% Q/Pn | Value of Q/Pn at point (U5,Q5) on the Q(U) mode curve |
| V5 | 0-110% VRated | Grid voltage limit at point (U5,Q5) on the Q(U) mode curve |
| Q6 | -60% -60% Q/Pn | Value of Q/Pn at point (U6,Q6) on the Q(U) mode curve |
| V6 | 0-110% VRated | Grid voltage limit at point (U6,Q6) on the Q(U) mode curve |
| RMpTime | 0-1000s | Increase or decrease the time required for the reactive power to reach the specified value of the curve. |

"Q(U)" Mode Parameters Explanation

“Q(P)” Mode

The reactive power output by the inverter is controlled by the active power of the inverter.

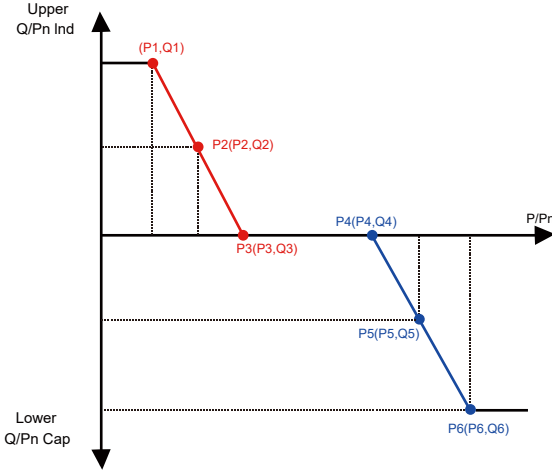

Pic 8.25 Reactive Power Regulation Curve in Q(P) Mode

| | | | |
|------------------------|-------|-----------|--------|
| MENU» Setup» Run Param | | | |
| ActiveP | 31% | SelfCheck | 20S |
| QMode | QP | Island | OFF |
| ReactP | 0.0% | Meter | ON |
| PF | 1.000 | Limiter | OFF |
| Fun_ISO | ON | Feed_In | 0% |
| Fun_RCD | ON | MPPT Num | 6 |
| | OK | | Cancel |

| | | | |
|------------|--------|----|--------|
| QP Setting | | | |
| P1 | 80.0% | Q1 | -25.0% |
| P2 | 90.0% | Q2 | 0.0% |
| P3 | 110.0% | Q3 | 0.0% |
| P4 | 120.0% | Q4 | 25.0% |
| P5 | 120.0% | Q5 | 25.0% |
| P6 | 120.0% | Q6 | 25.0% |
| | Back | | |

| parameter | Range | description |
|-----------|----------------|--|
| P1 | 0%-100% Pn | Value of Q/Pn at point (P1,Q1) on the Q(P) mode curve |
| Q1 | -60% -60% Q/Pn | Grid voltage limit at point (P1,Q1) on the Q(P) mode curve |
| P2 | 0%-100% Pn | Value of Q/Pn at point (P2,Q2) on the Q(P) mode curve |
| Q2 | -60% -60% Q/Pn | Grid voltage limit at point (P2,Q2) on the Q(P) mode curve |
| P3 | 0%-100% Pn | Value of Q/Pn at point (P3,Q3) on the Q(P) mode curve |
| Q3 | -60% -60% Q/Pn | Grid voltage limit at point (P3,Q3) on the Q(P) mode curve |
| P4 | 0%-100% Pn | Value of Q/Pn at point (P4,Q4) on the Q(P) mode curve |
| Q4 | -60% -60% Q/Pn | Grid voltage limit at point (P4,Q4) on the Q(P) mode curve |
| P5 | 0%-100% Pn | Value of Q/Pn at point (P5,Q5) on the Q(P) mode curve |
| Q5 | -60% -60% Q/Pn | Grid voltage limit at point (P5,Q5) on the Q(P) mode curve |
| P6 | 0%-100% Pn | Value of Q/Pn at point (P6,Q6) on the Q(P) mode curve |
| Q6 | -60% -60% Q/Pn | Grid voltage limit at point (P6,Q6) on the Q(P) mode curve |

"Q(P)" Mode Parameters Explanation

"PU" Mode

The reactive power output of the inverter varies in response to the grid voltage

| | | | |
|------------------------|------|--------|------|
| MENU» Setup» Run Param | | | |
| ARC | OFF | Vref | 0.0V |
| OFDerate | OFF | | |
| UFUprate | OFF | | |
| PU | ON | | |
| WGra | 0.0% | | |
| Sunspec | OFF | | |
| OK | | Cancel | |

| PU Setting | | | |
|------------|------|----|------|
| U1 | 0.0% | P1 | 0.0% |
| U2 | 0.0% | P2 | 0.0% |
| U3 | 0.0% | P3 | 0.0% |
| U4 | 0.0% | P4 | 0.0% |

Back

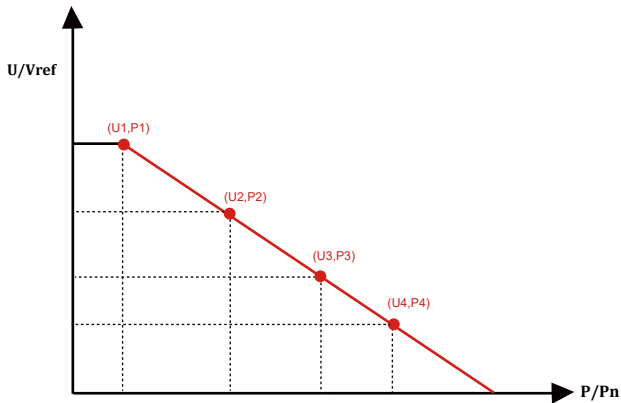

Pic 8.26 Active Power Regulation Curve in PU Curve

| parameter | Range | description |
|-----------|---------------|--|
| P1 | 0%-110% Pn | Value of P/Pn at point (P1,U1) on the PU mode curve |
| U1 | 0% -150% Vref | Grid voltage limit at point (P1,U1) on the PU mode curve |
| P2 | 0%-110% Pn | Value of P/Pn at point (P2,U2) on the PU mode curve |
| U2 | 0% -150% Vref | Grid voltage limit at point (P2,U2) on the PU mode curve |
| P3 | 0%-110% Pn | Value of P/Pn at point (P3,U3) on the PU mode curve |
| U3 | 0% -150% Vref | Grid voltage limit at point (P3,U3) on the PU mode curve |
| P4 | 0%-110% Pn | Value of P/Pn at point (P4,U4) on the PU mode curve |
| U4 | 0% -150% Vref | Grid voltage limit at point (P4,U4) on the PU mode curve |

"PU" Mode Parameters Explanation

8.5.3 Protect Param

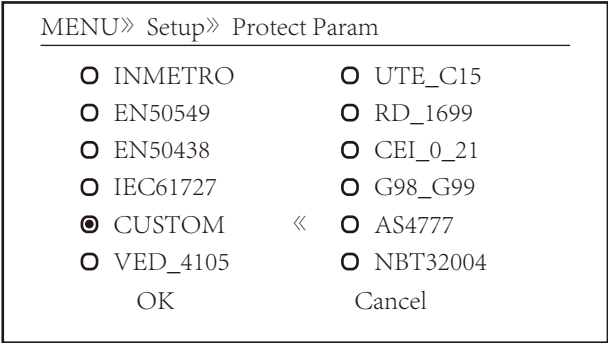

Pic 8.24 Protect Param



Note:
Engineer only.

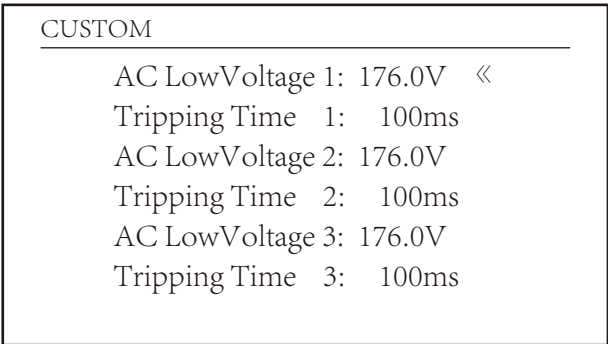
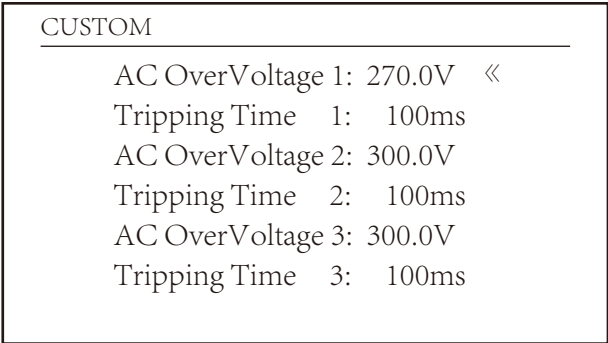

CUSTOM

AC OverFreq 1: 52.00Hz «
Tripping Time 1: 2000ms
AC OverFreq 2: 53.00Hz
Tripping Time 2: 500ms
AC OverFreq 3: 54.00Hz
Tripping Time 3: 200ms

CUSTOM

AC LowFreq 1: 48.00Hz «
Tripping Time 1: 2000ms
AC LowFreq 2: 47.00Hz
Tripping Time 2: 500ms
AC LowFreq 3: 46.00Hz
Tripping Time 3: 200ms

CUSTOM

Rated Voltage 220/380V «

OK Cancel

Pic 8.25 "CUSTOM"

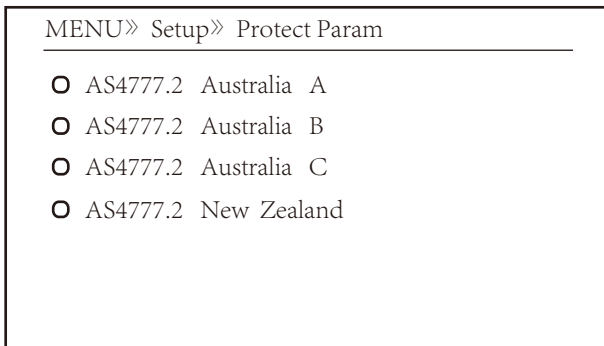
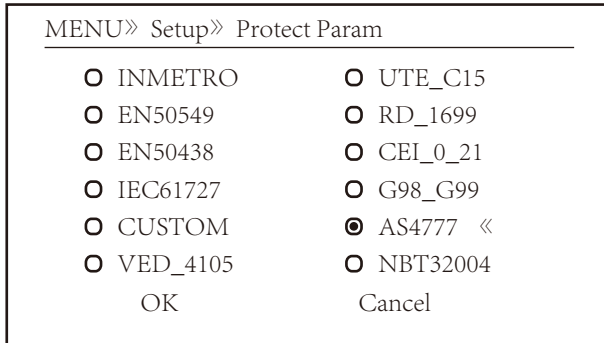

Pic 8.26 “AS4777”

8.5.5 Comm. Param

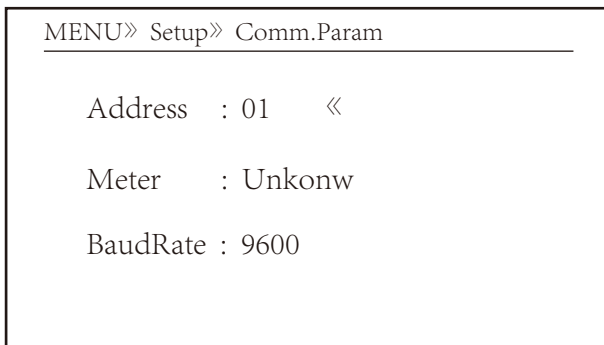

Pic 8.27 Communication param

9. Repair and Maintenance

String type inverter doesn't need regular maintenance. However, debris or dust will affect heat sink's thermal performance. It is better to clean it with a soft brush. If the surface is too dirty and affect the reading of LCD and LED lamp, you can use wet cloth to clean it up.



Warning:

When the device is running, the local temperature is too high and the touch can cause burns. Turn off the inverter and wait for it cooling, then you can clean and maintain.



Warning:

No solvent, abrasive materials or corrosive materials can be used for cleaning any parts of the inverter.

10. Error information and processing

Inverter has been designed in accordance with international grid tied standards for safety, and electromagnetic compatibility requirements. Before delivering to the customer the inverter has been subjected to several tests to ensure its optimal operation and reliability.

10.1 Error code

If there is any failure, the LCD screen will display an alarm message. In this case, the inverter may stop feeding energy into the grid. The alarm description and their corresponding alarm messages are listed Table 10.1.

| Error code | Description | Ongrid - Three Phase |
|-------------------|--|--|
| F21 | DC leakage flow fault | Hardly appear the code. Never ever happened so far. |
| F22 | Crash stop (if there is a stop button) | Contact your installer for help. |
| F23 | AC leakage current is transient over current | <ol style="list-style-type: none"> 1. This fault means the leakage current is above 30mA suddenly. Check whether DC power supply or solar panels is ok, then check 'Test data'-> 'dil' value is about 40; Then check the leakage current sensor or circuit. Check test data needs using big LCD. 2. Restart the inverter, if the fault still exists, contact your installer or Deye service. |
| F24 | DC insulation impedance failure | <ol style="list-style-type: none"> 1. Check Vpe resistance on main board or detection on control board. Check PV panels is OK. Many times this issue is the PV problem. 2. Check whether the PV panel (aluminum frame) is grounded well and inverter is grounded well. Open the cover of inverter and then check the inside ground cable is fixed well on the shell. 3. Check if the AC/DC cable, terminal block are shorted to ground or the insulation is damaged. 4. Restart the inverter, if the fault still exists, contact your installer or Deye service. |
| F25 | DC feedback fault | Hardly appear the code. Never ever happened so far. |
| F26 | The DC busbar is unbalanced | <ol style="list-style-type: none"> 1. Check whether the 'BUSN' cable or driver board power supply cable is loose. 2. Restart the inverter, if the fault still exists, contact your installer or Deye service. |
| F27 | DC end insulation error | Hardly appear the code. Never ever happened so far. |
| F28 | Inverter 1 DC high fault | Hardly appear the code. Never ever happened so far. |
| F29 | AC load switch failure | Hardly appear the code. Never ever happened so far. |
| F30 | AC main contactor failure | <ol style="list-style-type: none"> 1. Check relays and AC voltage of relays. 2. Check relays driver circuit. Check if the software is not suitable for this inverter. (Old inverter not have relays detection function) 3. Restart the inverter, if the fault still exists, contact your installer or Deye service. |
| F31 | Dc boost soft start | <ol style="list-style-type: none"> 1. At least one Relay can't be closed. Check relays and its driver signal. (Old inverter not have relays detection function) 2. Restart the inverter, if the fault still exists, contact your installer or Deye service. |
| F32 | Inverter 2 dc high fault | Hardly appear the code. Never ever happened so far. |
| F33 | AC over current | Hardly appear the code. Never ever happened so far. |
| F34 | AC current over load | Hardly appear the code. Never ever happened so far. |
| F35 | No AC grid | <ol style="list-style-type: none"> 1. Check AC grid voltage. Check AC voltage detection circuit. Check if the AC connector in good condition. Check whether the AC grid is normal in voltage. 2. Restart the inverter, if the fault still exists, contact your installer or Deye service. |
| F36 | AC grid phase error | Hardly appear the code. Never ever happened so far. |
| F37 | AC three-phase voltage unbalance failure | Hardly appear the code. Never ever happened so far. |
| F38 | AC three-phase current unbalance failure | Hardly appear the code. Never ever happened so far. |

| Error code | Description | Ongrid - Three Phase |
|-------------------|--|---|
| F39 | AC over current(one cycle) | 1. Check AC current sensor and its circuit. 2. Restart the inverter, if the fault still exists, contact your installer or Deye service. |
| F40 | DC over current | Hardly appear the code. Never ever happened so far. |
| F41 | AC Line W,U over voltage | Check the AC voltage protection setting. And Check if the AC cable is too thin.Check the voltage difference between LCD and meter. |
| F42 | AC Line W,U low voltage | Check the AC voltage protection setting. Check the voltage difference between LCD and meter. Also need to check whether AC cables are all firmly and correctly connected. |
| F43 | AC Line V,W over voltage | Check the AC voltage protection setting.And Check if the AC cable is too thin.Check the voltage difference between LCD and meter. |
| F44 | AC Line V,W low voltage | Check the AC voltage protection setting. Check the voltage difference between LCD and meter. Also need to check whether AC cables are all firmly and correctly connected. |
| F45 | AC Line U,V over voltage | Check the AC voltage protection setting.And Check if the AC cable is too thin.Check the voltage difference between LCD and meter. |
| F46 | AC Line U,V low voltage | Check the AC voltage protection setting. |
| F47 | AC Over frequency | Check the frequency protection setting. |
| F48 | AC lower frequency | Check the frequency protection setting. |
| F49 | U phase grid current DC component over current | Hardly appear the code. Never ever happened so far. |
| F50 | V phase grid current DC component over current | Hardly appear the code. Never ever happened so far. |
| F51 | W phase grid current DC component over current | Hardly appear the code. Never ever happened so far. |
| F52 | AC inductor A, phase current DC current high | Hardly appear the code. Never ever happened so far. |
| F53 | AC inductor B, phase current DC current high | Hardly appear the code. Never ever happened so far. |
| F54 | AC inductor C, phase current DC current high | Hardly appear the code. Never ever happened so far. |
| F55 | DC busbar voltage is too high | 1. Check PV voltage and Ubus voltage and its detection circuit. If the PV input voltage exceeds the limit, please reduce the number of solar panels in series. 2. For Ubus voltage, please check the LCD display. |
| F56 | DC busbar voltage is too low | 1. It tells the PV input voltage is low and it always happens in the early morning. 2. Check PV voltage and Ubus voltage. When inverter is running, then showing F56, maybe Loss of driver or need update firmware. 3. Restart the inverter, if the fault still exists, contact your installer or Deye service. |
| F57 | AC reverse irrigation | AC reverse irrigation. |
| F58 | AC grid U over current | Hardly appear the code. Never ever happened so far. |

| Error code | Description | Ongrid - Three Phase |
|-------------------|--|---|
| F39 | AC over current(one cycle) | 1. Check AC current sensor and its circuit. 2. Restart the inverter, if the fault still exists, contact your installer. |
| F40 | DC over current | Hardly appear the code. Never ever happened so far. |
| F41 | AC Line W,U over voltage | Check the AC voltage protection setting. And Check if the AC cable is too thin.Check the voltage difference between LCD and meter. |
| F42 | AC Line W,U low voltage | Check the AC voltage protection setting. Check the voltage difference between LCD and meter. Also need to check whether AC cables are all firmly and correctly connected. |
| F43 | AC Line V,W over voltage | Check the AC voltage protection setting.And Check if the AC cable is too thin.Check the voltage difference between LCD and meter. |
| F44 | AC Line V,W low voltage | Check the AC voltage protection setting. Check the voltage difference between LCD and meter. Also need to check whether AC cables are all firmly and correctly connected. |
| F45 | AC Line U,V over voltage | Check the AC voltage protection setting.And Check if the AC cable is too thin.Check the voltage difference between LCD and meter. |
| F46 | AC Line U,V low voltage | Check the AC voltage protection setting. |
| F47 | AC Over frequency | Check the frequency protection setting. |
| F48 | AC lower frequency | Check the frequency protection setting. |
| F49 | U phase grid current DC component over current | Hardly appear the code. Never ever happened so far. |
| F50 | V phase grid current DC component over current | Hardly appear the code. Never ever happened so far. |
| F51 | W phase grid current DC component over current | Hardly appear the code. Never ever happened so far. |
| F52 | AC inductor A, phase current DC current high | Hardly appear the code. Never ever happened so far. |
| F53 | AC inductor B, phase current DC current high | Hardly appear the code. Never ever happened so far. |
| F54 | AC inductor C, phase current DC current high | Hardly appear the code. Never ever happened so far. |
| F55 | DC busbar voltage is too high | 1. Check PV voltage and Ubus voltage and its detection circuit. If the PV input voltage exceeds the limit, please reduce the number of solar panels in series. 2. For Ubus voltage, please check the LCD display. |
| F56 | DC busbar voltage is too low | 1. It tells the PV input voltage is low and it always happens in the early morning. 2. Check PV voltage and Ubus voltage. When inverter is running, then showing F56, maybe Loss of driver or need update firmware. 3. Restart the inverter, if the fault still exists, contact your installer. |
| F57 | AC reverse irrigation | AC reverse irrigation. |
| F58 | AC grid U over current | Hardly appear the code. Never ever happened so far. |

| Error code | Description | Ongrid - Three Phase |
|-------------------|---------------------------------|---|
| F59 | AC grid V over current | Hardly appear the code. Never ever happened so far. |
| F60 | AC grid W over current | Hardly appear the code. Never ever happened so far. |
| F61 | Reactor A phase over current | Hardly appear the code. Never ever happened so far. |
| F62 | Reactor B phase over current | Hardly appear the code. Never ever happened so far. |
| F63 | ARC fault | 1. Check PV module cable connection and clear the fault; 2. Seek help from us, if can not go back to normal state. |
| F64 | IGBT heat sink high temperature | 1. Check temperature sensor. Check if firmware is suitable for the hardware. Check if the inverter is its right model. 2. Restart the inverter, if the fault still exists, contact your installer. |

Table10.1 Error codes and their solutions



Note:

If your string inverter has any of the fault information shown in Table 10-1, and when you reset the machine and still don't solve the problem, please contact our distributor and provide the below details:

1. Serial number of the inverter;
2. The distributor/dealer of the inverter(if available);
3. Installation date;
4. The discription of problem(include LCD'error code and LED status indicator lights);
5. Your contact details.

11.Specification

| Model | SUN-25K-G02-LV | SUN-30K-G02-LV |
|---|--|-----------------------|
| Input Side | | |
| Max.DC Power(kW) | 32.5 | 39 |
| Max.DC Input Voltage(V) | 800 | |
| Start-up DC Input Voltage(V) | 250 | |
| MPPT Operating Range(V) | 200~700 | |
| Max.DC Input Current(A) | 40+40+40 | 40+40+40+40 |
| Max. Short Circuit Current (A) | 60+60+60 | 60+60+60+60 |
| Number of MPPT/Strings per MPPT | 3/3 | 4/3 |
| MAX inverter backfeed current (A) | 0 | |
| Output Side | | |
| Rated Output Power(kW) | 25 | 30 |
| Max.Active Power(kW) | 27.5 | 33 |
| Rated AC Grid Voltage(V) | 127/220 | |
| AC Grid Voltage Range(V) | 176~242 (this may vary with grid standards) | |
| Rated Grid Frequency(Hz) | 60 / 50 (Optional) | |
| Operating Phase | Three phase | |
| Rated AC Grid Output Current(A) | 65.6 | 78.7 |
| Max.AC Output Current(A) | 72.2 | 86.6 |
| Maximum output fault current (a.c. A, peak) | 125.2 | 150.2 |
| Maximum output overcurrent protection (a.c. A,peak) | 139.1 | 166.9 |
| Output Power Factor | 0.8 leading to 0.8 lagging | |
| Grid Current THD | <3% | |
| DC Injection Current(mA) | <0.5% | |
| Grid Frequency Range | 47-52 or 57-62 (optional) | |
| Efficiency | | |
| Max.Efficiency | 98.7% | |
| Euro Efficiency | 98% | |
| MPPT Efficiency | >99% | |
| General Data | | |
| Size(mm, W×H×D) | 647.5×537×303.5 | |
| Weight(kg) | 44.5 | |
| Topology | Transformerless | |
| Internal consumption | <1W(Night) | |
| Operating temperature | -25 ~ 65 C ,>45 C derating | |
| Ingress protection | IP65 | |
| Noise Emission(Typical) | <45dB | |
| Cooling Concept | Smart cooling | |
| Max. operation altitude | 2000m | |
| Warranty | 5 Years | |
| Grid Connection Standard | CEI 0-21,VDE-AR-N 4105,NRS 097,IEC 62116,IEC 61727,G99,G98,VDE 0126-1-1,RD 1699,C10-11 | |
| Operation surrounding humidity | 0~100% | |
| Safety EMC / Standard | IEC/EN 62109-1,IEC/EN 62109-2,IEC/EN 61000-6-1, IEC/EN 61000-6-2,IEC/EN 61000-6-3,IEC/EN 61000-6-4 | |

| General Data | |
|---------------------|----------------------|
| DC Connection | MC-4 mateable |
| AC Connection | IP65 rated plug |
| Display | LCD1602 |
| Interface | RS485/RS232/Wifi/LAN |

